

Effects and impacts of vessel activity on the Kittlitz's Murrelet (*Brachyramphus  
brevirostris*) in Glacier Bay, Alaska

Alison M. Agness

A thesis  
submitted in partial fulfillment of the  
requirements for the degree of

Master of Science

University of Washington

2006

Program Authorized to Offer Degree:  
School of Aquatic and Fishery Sciences

## TABLE OF CONTENTS

	Page
List of Figures .....	iii
List of Tables .....	vi
Introduction.....	1
Chapter 1: Vessel disturbance of birds: Identifying impacts and evaluating scientific rigor in field studies.....	3
Summary .....	3
Introduction.....	4
Methods.....	7
Results.....	9
Discussion.....	19
Notes to Chapter 1 .....	30
Chapter 2: Effects of vessel activity on the near shore ecology of the Kittlitz’s Murrelet ( <i>Brachyramphus brevirostris</i> ) in Glacier Bay, Alaska.....	35
Summary .....	35
Introduction.....	36
Methods.....	39
Results.....	46
Discussion.....	51
Notes to Chapter 2 .....	66
Chapter 3: Energetic impacts of vessel disturbance on the Kittlitz’s Murrelet ( <i>Brachyramphus brevirostris</i> ): a simulation model approach .....	69
Summary .....	69
Introduction.....	70
Methods.....	74
Results.....	82
Discussion.....	84
Notes to Chapter 3 .....	99
Conclusions.....	103
Bibliography .....	105
Appendix A. Using at-sea observations of fish holding Kittlitz’s Murrelet ( <i>Brachyramphus brevirostris</i> ) to assess breeding phenology and chick diet .....	114
Summary .....	114
Introduction.....	115
Methods.....	117
Results.....	120
Discussion.....	122

Notes to Appendix A ..... 131

## List of Figures

Figure	Page
1.1 Review of relevant disturbance literature, and the corresponding scientific rigor ranking (Hill et al. 1997), from 1976 to present.....	29
2.1 Location of field sites in Glacier Bay, Alaska, denoted with black circles. The four sites furthest to the northwest were glacial, and the three remaining sites to the southeast were non-glacial.....	58
2.2 Best regression tree model of biological and environmental influences on Kittlitz's Murrelet near shore density at the daily time scale. For each branch the first numeric indicates mean density (Kittlitz's/km <sup>2</sup> ).....	59
2.3 Best regression tree model of biological, environmental, and vessel factor (daily vessel rate) influences on Kittlitz's Murrelet near shore density at the daily time scale. For each branch the first numeric indicates mean density (Kittlitz's/km <sup>2</sup> ).....	60
2.4 Best regression tree model of environmental, biological, and vessel factor (daily vessel rate) influences on Kittlitz's Murrelet group dynamics at the daily time scale. For each branch the first numeric indicates mean group size.....	61
2.5 Median and quartile plots of Kittlitz's Murrelet behaviors (proportion of Kittlitz's per behavioral category: loafing, diving, flying) summarized in the presence and absence of vessel activity. Significant behavioral change was detected for loafing (decrease) and flying (increase) in the presence of vessels.....	62
2.6 Best regression tree model of environmental, biological, and vessel factor (vessel size, speed, and approach distance) influences on variability in the immediate behavioral response of non-fish holding Kittlitz's Murrelet. For each leaf, the first numeric indicates the amount of unexplained deviance remaining. The y-axis of individual branch plots is the mean proportion of Kittlitz's engaged in each behavior category.....	63

2.7 Best regression tree model of environmental, biological, and vessel factor (vessel size, speed, and approach distance) influences on variability in the immediate behavioral response of fish holding Kittlitz's Murrelet. For each leaf, the first numeric indicates the amount of unexplained deviance remaining. The y-axis of individual branch plots is the mean proportion of Kittlitz's engaged in each behavior category.....	64
2.8 Best regression tree model of environmental, biological, and vessel factor (daily vessel rate) influences on Kittlitz's Murrelet behavior at the daily time scale. For each leaf, the first numeric indicates the amount of unexplained deviance remaining. The y-axis of individual branch plots is the mean proportion of time spent per behavioral category.....	65
3.1 Location of field sites used by Agness (Thesis Chapter 2) in Glacier Bay, Alaska, denoted with black circles. The four sites furthest to the northwest were glacial, and the three remaining sites to the southeast were non glacial.....	90
3.2 A schematic diagram of the conceptual framework and structure for fish holder model simulations. Each daily energy budget calculated represented one simulation.....	91
3.3 A schematic diagram of the conceptual framework and structure non-fish holder model simulations. Each daily energy budget calculated represented one simulation.....	92
3.4 Mean energy difference and 95% confidence intervals from four independent sample t-tests which compared the energy budget of fish holding and non-fish holding Kittlitz's Murrelet under three vessel traffic scenarios: maximum energy (M), average (A) and worst (W) scenarios. Test 1: non-fish holder A vs. M ( $M > A$ ); Test 2: fish holder A vs. M ( $A = M$ ); Test 3: non-fish holder W vs. A ( $W > A$ ); Test 4: fish holder W vs. A ( $W > A$ ). Asterisks indicate significant t-test results.....	93
3.5 Distribution of model simulations for the fish holder average day scenario.....	94
3.6 Distribution of model simulations for the best case energy scenario .....	95
3.7 Distribution of model simulations by for the non-fish holder average day scenario.....	96

3.8 Distribution of model simulations for the fish holder worst case scenario.....	97
3.9 Distribution of model simulations for the non-fish holder worst case scenario.....	98
A.1 The cumulative frequency of Kittlitz's Murrelet fish-holding behavior observed across the dates of study. A logistic curve is fitted to the data-set. The vertical dashed line indicates the inflection point (3 July) of the logistic regression curve.....	129
A.2 Frequency of occurrence of fish-holding behavior by birds in flocks of different size (n=247).....	130

## List of Tables

Table	Page
1.1 The composition of disturbance classification (acoustic and visual) and disturbance sources from the reviewed literature relevant to the discussion of vessel disturbance impacts on birds.....	25
1.2 Biological variables included in analysis to determine the effects of vessel disturbance on birds.....	26
1.3 Environmental variables analyzed in disturbance studies reviewed.....	27
1.4 The relative effects attributed to vessel type for studies that compare effects of more than one vessel type.....	28
2.1 Sources of variability included in daily time scale analysis which potentially influence the response variables (density, group size, and behaviors).....	55
2.2 Vessel variables included in immediate time scale analyses.....	56
2.3 Summary of hypothesis tests for the response variables at each time scale.....	57
3.1 Model parameters used for each vessel loop in a simulation for the probability of occurrence of disturbance characteristics and consequent probability of Kittlitz's Murrelet flight. Probabilities were derived from field study (Chapter 2).....	88
3.2 Exploratory analysis of distribution tails and associated percentile tests of the two comparative tests: average day scenario vs. best case scenario and worst case scenario vs. average day scenario. The energy difference is shown at each distribution percentile (kJ) per comparative test, along with the respective number of fish that a murrelet would have to consume to overcome the associated energetic costs.....	89
A.1 Frequency of occurrence of fish species that were positively identified (n=58 of 247) in the bill of Kittlitz's holding fish.....	126
A.2 Frequency of occurrence of positively identified fish species held by Kittlitz's in glacial (n=51 of 222) vs. non-glacial (n=7 of 25) near shore habitat types.....	127
A.3 Frequency of occurrence of fish-holding behavior (n=247) observed for three times of day: morning, mid-day and evening.....	128

## ACKNOWLEDGEMENTS

I thank the School of Aquatic and Fishery Sciences (SAFS) and the Washington Cooperative Fish and Wildlife Research Unit of University of Washington for support of and commitment to my educational development. In particular, I thank my thesis advisor Glenn VanBlaricom for his contribution to my academic and research program at SAFS.

In addition, my advisory committee (Glenn VanBlaricom, James Ha, Julia Parrish, Loveday Conquest, and John Piatt) has been a wonderful resource to ask advice, obtain feedback on progress, and provide assistance in the learning process throughout my graduate experience. I am very thankful for funding support from the Alaska Department of Fish and Game, which has been crucial to my thesis research, as well as supporting my education and cost of living.

Thanks for logistical support in the field from Glacier Bay National Park, and the Piatt field team from USGS Alaska Science Center of Marc Romano and Yumi Arimitsu. Quite possibly most important, my field crew was outstanding! Thanks to Kim Weersing, Traci Caddy, Leilani Nussman, and Steve Scott for your many hours of observation behind the scope, data recording on the palm, and vessel handling in the Bay especially on those cold, wet days.



Thank you to the graduate students of SAFS, including the VanBlaricom lab and the Parrish lab for your help along the way. Thanks to my office mate Donna, who was always willing to field a question. Big thanks to Kristin Marshall and Lucy Flynn for technical guidance and help with computer code. Finally, my family and friends have been incredible cheerleaders, following my progress and listening to the development of ideas from the beginning. I am extremely grateful for their love.

## **DEDICATION**

To my dad whose love of the ocean and wild places first sparked my interest in biology. And whose sudden death instilled in my life the importance of being committed and present to the things that will bring you the greatest joy. His life and death has shaped my path.

## INTRODUCTION

The overall goal of my thesis research was to assess the potential impact of vessel traffic on the Kittlitz's Murrelet (*Brachyramphus brevirostris*) in Glacier Bay, Alaska. My research was driven by the 'species of concern' status of the Kittlitz's Murrelet under the federal US Endangered Species Act. This research was important to the conservation of the Kittlitz's Murrelet because vessel traffic may contribute to species declines documented in recent years. In order to address my overall research goal I conducted a literature review and field investigations.

For the first component of my thesis, I reviewed literature on the effects of vessels on bird populations which gave me a broad understanding of the potential consequences of bird-vessel interactions (Chapter 1). I also conducted field investigation on the effects of vessels on the Kittlitz's Murrelet in Glacier Bay, Alaska which resulted in the remaining two components of my thesis. The second component of my thesis work looked at the measurable effects of vessels on the near shore density, group dynamics and behaviors of the Kittlitz's Murrelet (Chapter 2). The third component of my thesis work used computer simulation models to examine the energetic cost of Kittlitz's Murrelet flight response to vessels under different vessel traffic scenarios (Chapter 3). These models were used to assess the energetic impact of vessels on the species.

My field investigations were additionally used to understand the breeding phenology of the Kittlitz's Murrelet, a component of the species ecology that is not well known. This information was contained in an Appendix (Append. 1) at the end of my thesis. Each chapter of my thesis and the appendix were formatted as individual manuscripts for publication in different scientific journals. For this reason some of the information in chapters was repetitive, such as some introduction and methods information. Because different journals require specific formatting requirements, the format of individual chapters was not the same. Thank you for your interest in my research, and please contact me with any questions that may arise when reading this thesis.

## **Chapter 1. Vessel disturbance of birds: Identifying impacts and evaluating scientific rigor in field studies**

### **Summary**

Presently, ecotourism is a growing business sector that reaches remote wild lands and marine coastal habitats. Ecotourism and private recreation often use watercraft for recreational travel in ecologically sensitive places. It follows that water-birds may be experiencing unprecedented levels of disturbance, and likely face conservation challenges as a result. Many studies have been conducted to assess the impact of humans on waterbirds. Here we offer a critical evaluation of published peer-reviewed papers to compare scientific rigor and spatial scale, highlight factors influential to the effects of vessel disturbance and impacts, summarize the responses of avian species to vessel disturbance, and identify gaps in research. Most studies published to date target behavioral responses to vessel disturbance rather than demographic responses. Although knowledge of behavioral response is useful, these conclusions alone do not allow managers to ensure that decisions are not impacting a species' ability to persist. Studies report that vessel disturbance can cause increased offspring mortality, loss of suitable habitat, and increased energetic costs that can constitute impact at high rates of vessel traffic. Avian species respond differently to vessel disturbance; therefore, species-specific research is needed to understand particular species of interest. Our review suggests that vessel disturbance studies are becoming more rigorous, clearly a desirable trend. We stress the importance of structuring analytical designs that include uncontrolled variables in field studies of vessel disturbance.

## **Introduction**

Human population growth continues to be implicated as a leading conservation problem (Ehrlich & Holdren 1971; Sisk et al. 1994; Cincotta et al. 2000). With this growth, many aspects of human development, including recreation and ecotourism, may require restriction to ensure the continued existence of ecologically sensitive species and places (Heckel et al. 2003; Rivera 2004). Increasingly, species and populations of birds are at risk in a conservation context for a variety of reasons that include anthropogenic and climate-related changes leading to habitat loss and degradation (Newton 2004; Norris et al. 2004; Foster et al. 2004). Ecotourism is presently a burgeoning sector of human economies, reaching wild lands and wild marine coastal habitats that have remained remote and inaccessible until recently. People engaged in ecotourism and private recreation often utilize watercraft as vehicles for recreational travel in ecologically sensitive places (Hall 2001). It follows that water-birds may be experiencing unprecedented levels of disturbance as a result of human desire to observe pristine wildlife.

As ecotourism opportunities increase, it is anticipated that the use of commercial watercraft will also increase. Private use of smaller vessels as a form of recreation is also on the rise (Figure 1 of Hill et al. 1997). Because of this increase in vessel traffic, vessel disturbance of birds has become an increasingly prominent topic of conservation research. Managers need to develop buffer zones in order to isolate birds from vessel disturbance

and to quantify the impact of recreational vessel use on avian species so that they can evaluate appropriate thresholds for recreation and ecotourism use levels.

There is a substantial body of work on vessel disturbance research on avian species, but issues of study design, temporal and spatial variability, species-specific response patterns, and a lack of consistent reporting of uncontrolled environmental, biological or vessel related variables make it difficult to compare and synthesize study results. Here we offer a critical evaluation of peer-reviewed papers with four specific objectives in mind: (1) To summarize the results of vessel disturbance studies on birds in order to compare scientific rigor and spatial scale; (2) To highlight factors influential to the detection of vessel disturbance effects and impacts on waterbird species; (3) To summarize the responses of avian species to vessel disturbance, and (4) To identify current gaps in this research field.

#### *Definition of terms*

A bird-vessel interaction occurs when birds respond to visual or sound stimuli created by the presence of vessels. Responses can be categorized as behavioral, physiological, or demographic. Behavioral and physiological responses deal with proximate effects of disturbance to birds. Demographic responses involve population level patterns such as reproduction, survival, or changes in density, and abundance. The literature describes the responses of birds to vessel disturbance in terms of effects or impacts.

A vessel disturbance is said to have a significant effect if the response variable (i.e., behavior state) changes in the presence of vessels. However, observation of an effect provides little information about the biological importance of the effect. An effect is considered *negative* if the disturbance negatively influences the response variable (e.g., behavior state changes in the presence of vessels), *positive* if the disturbance positively influences the bird dependent variable (e.g., bird abundance increases in the presence of vessels), and *none* if the disturbance does not influence the dependent variable under investigation (i.e., there is no difference behavior state when vessels are present or absent).

A vessel disturbance is said to cause an impact if the avian response significantly influences fitness (reproduction or survival) either directly (i.e., including direct mortality or nest failure) or indirectly (i.e., including reduced body condition, foraging effort, or time spent incubating). Impact is *negative* if vessel disturbance negatively influences the fitness of birds (e.g., vessels cause reduced survival or reproductive success), *positive* if vessel disturbance positively influences fitness (e.g. vessels cause increased survival or reproductive success), and *none* if no influences on fitness are detected.

## **Methods**

We used web-based literature search resources and published reviews of disturbance effects (Boyle & Samson 1985; Hockin et al. 1992; Hill et al. 1997; Carney & Sydeman



2000, Nisbet 2000) to identify relevant research papers. Thirty-one studies of vessel disturbance and seven additional studies of mechanized disturbance to birds that were conducted between 1976 and the present were identified, summarized and evaluated. Other mechanized disturbance studies were included in this review to supplement gaps in knowledge (i.e., acoustic disturbance and demographic implications). Bird response to other mechanized disturbance considers many of the same influential factors considered by vessel disturbance studies, making results of such studies informative to a review of vessel disturbance. In addition, a number of papers relevant to the development of better methodology were reviewed to inform the discussion of future research and current research gaps. Studies were classified by three response categories; behavioral, physiological, and/or demographic.

Spatial scale was categorized (Hill et al. 1997) as local, regional, and flyway for each of the papers considered. Local population scale refers to site specific factors influencing a species' population dynamics, without knowledge of the larger landscape processes affecting sites across the species range. Regional population scale refers to a suite of spatially separate sites that represent sub-populations of a species with potentially variable survival and/or reproductive rates, and where the sub-populations share common habitat during a temporal period, such as wintering habitat. Flyway population scale refers to a number of species with measured or known survival and/or reproductive rates at the sub-population level, across the species ranges, incorporating potential variability in species densities across the temporal cycle of species movement (Hill et al. 1997).

Papers were scored for scientific rigor using a ranking scale of 1 to 4 developed by Hill et al. (1997). Specific criteria were used to evaluate the potential clarity of interpretation and extrapolation of results permitted by the study design. The four criteria are as follows:

- (1) Use of an experimental control, a before-and-after study or a study with and without disturbance.
- (2) Use of more than two areas studied at the same time with known or measured levels of disturbance, or a study utilizing a gradient of disturbance.
- (3) Correlative study amassing a large dataset on a number of sites across a number of years, with environmental data measured and some index of human use or disturbance level recorded.
- (4) Study based on simple observation without hypothesis testing.

After ranking and summarizing each paper, descriptive statistics or basic frequency of occurrence enumeration were used to assess trends in reported species effects and impacts across papers. Vessel related variables as well as independent environmental and biological variables used by studies were also summarized to determine the consistency of reporting and detail of disturbance relationships described across studies.

## Results

### *Evaluating vessel disturbance studies with common criteria*

Understanding the scientific rigor and spatial scale of vessel disturbance studies helps to clarify the importance of attention to study design. The scientific rigor and volume of vessel disturbance research on birds has improved from 1976 to present (Figure 1).

Relatively fewer observational studies and more criterion 1 studies have been produced in the past decade. The research approach to investigating vessel disturbance on avian species has generally focused on the potential visual disturbance of vessels (Table 1.1).

A few studies consider the potential effects of acoustic disturbance. Due to the small number of acoustic disturbance studies involving vessels, papers reporting on other sources of acoustic disturbance (n=7 studies: aircraft, helicopter, automobile, seismic testing, and urban noise) were sought for the purpose of this review.

The majority (84%) of papers reviewed were conducted at a local spatial scale. Three studies done at the regional spatial scale (Mikola et al. 1994; Reijnen et al. 1995; Robinson & Pollitt 2002), and one study carried out at the flyway spatial scale (Tuite et al. 1984) were of criteria levels 1 or 2.

### *Factor influence on vessel disturbance effects and impacts*

Biological, environmental, and vessel related variables were found to influence the response of birds to vessel disturbance. We review use of such factors among studies,

and highlight variables that significantly contribute to the understanding of bird-vessel interaction in the majority of studies. The inclusion of biological factors as variables in analysis of vessel disturbance effects on birds varied across studies (Table 1.2). Most papers (68%) reviewed did not include biological variables in analyses to determine the effects of disturbance. Species-specific responses to vessel disturbance were found by every paper that included species (n=11) as a factor in data analysis (Bramford et al. 1990; Bratton 1990; Pierce et al. 1993; Reijnen et al. 1995; Rodgers and Smith 1995, 1997; Conomy et al. 1998; Ward et al. 1999; Rodgers & Schwikert 2002, 2003; Traut and Hostetler 2003).

Of the five papers which identify age as a variable, two provide data for more than one age-class. However, the effects of age on disturbance responses vary between studies. One study (Wood 1999) suggests that age class does not influence the behavioral response of Bald Eagles (*Haliaeetus leucocephalus*) to boating activity. A second study (Rodgers & Smith 1995) suggests that adult Least Terns (*Sterna antillarum*) and Black Skimmers (*Rynchops niger*) flush at greater distances from disturbing vessels than do mobile, independent nestlings of the same species.

Breeding season was investigated as a biological variable in three studies. Breeding season is not determined to be significant when investigating potential variability in behavioral response of Crested Tern (*Sterna bergii*) to aircraft noise (Brown 1990), or in a study of waterbird flush distance of incubating and brooding adults to vessel

disturbance (Rodgers & Smith 1995). However, breeding season is a significant factor affecting Northern Spotted Owl (*Strix occidentalis caurina*) behavioral response to helicopter visual and acoustic disturbance (Delaney et al. 1999), as well as Common Tern (*Sterna hirundo*) behavioral response to vessel disturbance (Burger 1998). In both studies breeding birds are less disturbed by vessel or helicopter presence during the nesting-phase than during the early breeding phase (Common Terns) or the post-fledge breeding phase (Northern Spotted Owl). The same general pattern was seen in studies that investigate breeding vs. non-breeding birds, where breeding birds were less responsive while in the nesting phase than non-breeding birds (Rodgers & Schwikert 2002). One study evaluates the effect of brood size on response of Velvet Scoter (*Melanitta fusca*) ducklings to boat activity, and determines that duckling mortality is less likely as brood size increases. Vessel disturbance is shown to scatter broods temporarily and to increase the potential for gull depredation of ducklings (Mikola et al. 1994).

More studies have investigated disturbance during spring and summer (n=25) than during fall or winter (n=13). Although the consequences of disturbance probably change across the biological cycle (breeding, migrating, stopover, wintering), only three studies, attempted to characterize vessel disturbance at a particular location across all seasons (Bramford et al. 1990; Pierce et al. 1993; Robinson & Politt 2002). All three studies report a significant seasonal effect. In general, studies characterized vessel disturbance during one (n=22) or two season(s) (n=13) at the relevant spatial scale. Overall, when

biological factors were included in analyses, such factors were commonly found to significantly influence bird response to vessel or other disturbance types reviewed.

The inclusion of environmental variables in analyses of vessel disturbance effects on birds was inconsistent across studies. Many papers (n=12) did not include environmental variables in analytical efforts (Table 1.3). Although the majority of papers (n=25) include at least one environmental variable in the analysis of disturbance effects, there is great discrepancy in the degree of detail among studies.

Only one of three studies that evaluated the effects of weather found a significant result (Burger & Galli 1987). Burger and Galli (1987) find that weather had a significant effect on the distribution of gulls, where vessel disturbance was investigated as a factor influencing distribution. Tide-related parameters are found to be significant in determining bird response in two of four studies that investigated tide effects (Burger & Galli 1987; Keller 1991). Habitat type is found to be a significant variable influencing bird response to vessels in three of six studies that included this variable (Kaiser & Fritzell 1984; Bratton 1990; Pierce et al. 1993). Habitat features such as lake size, pH, or shoreline structure were not found to be significant variables influencing bird response in any of the three studies that investigated such effects. Likewise, location within a site was not determined to be significant for the single study that addressed this variable (Burger & Galli 1987). Time of day was evaluated in many studies, but was determined

to have a significant influence over bird response in only a few instances (e.g. Bramford et al. 1990).

Vessel attributes were included in the analytical design of many of the studies we evaluated. Vessel type, size and speed were frequently measured, reported, and incorporated into analyses. Twenty-four different vessel types were characterized in research that we reviewed, ranging from motorboat (17 studies) to row boat (3 studies). However, most individual research studies typically characterized only 1-3 vessel types (Table 4). Two studies did not include the type of vessel accounting for disturbance in their analysis (type: 'boat', Burger & Galli 1987; Wood 1999), and the reporting of detail of vessel type was highly variable among studies.

The relative effects attributed to vessel type were inconsistent, in part due to the variability in reporting of vessel type and differences in transport among studies (Table 1.4). Motorized vessels caused relatively more disturbance than non-motorized in seven of ten studies that compared more than one vessel type. Airboat, jet ski, and personal watercraft vessel types were shown to cause relatively greater disturbance than motorboats of comparable size, suggesting that the greater wake spray, high speed, and high acoustic amplitude and frequency characteristic of the former likely influence the differences in species response (Burger 1998; Robinson & Politt 2002; Rodgers & Schwikert 2003; but see Rodgers and Schwikert 2002).

Vessel speed was measured and analyzed in 33% of vessel disturbance studies. Only four studies (Keller 1991; Pierce et al. 1993; Burger 1998; Ronconi & St Clair 2002) reported a gradient of vessel speed, and all other studies focus on one quantified speed (kph), or one speed level (e.g. 'slow' or 'fast'). The effects attributable to vessel speed were generally negative, and relatively faster speeds created greater disturbance than slower speeds. Four studies that incorporated a gradient of vessel speed into the analysis were useful in evaluating the effects of speed.

Vessel size was measured and analyzed as a variable by many (55%) of the studies under review. For the purpose of comparison across studies, four size categories were defined: very small (model or toy), small (<6 m), medium (7-12 m), large (>13 m). The majority of studies that report vessel size investigated the effects of small vessels (n= 13 of 18), which does not provide insights about size as a continuous variable. Only one study (Ronconi & St Clair 2002) reported a gradient of vessel size: small (vessel length <6 m), medium (6-10 m), and large (>10 m) vessel sizes, to determine the relative effects of size within a specific study design and context. Ronconi and St Clair (2002) find that boat size was a significant predictor of disturbance to Black Guillemots (*Cepphus grylle*). However the direction of the relationship was not consistent across the gradient of size. Unfortunately, the parameter boat size was complicated by uneven distribution of other boat descriptors (speed and approach distance, or distance between the boat and bird as the point of passage) across the range of vessel size classes.



Two studies listed as reporting large vessel size do not report actual vessel length. In these cases size was inferred from the vessel type characterization. One study characterized vessel type as “barge”, and the other as “ferry boat” (Belanger & Bedard 1989; Havera et al. 1992). Although both studies found negative effects of vessel disturbance, it is difficult to evaluate the influence of large vessel size on bird response based on available published data. Neither study provided data for vessel speed or approach distance, both of which were determined to be significant variables of disturbance effects in other studies (e.g. Burger 1998; Ronconi & St Clair 2002). Although approach distance, also called flush distance, can be a dependent variable in experimental stimulus-response studies (e.g. Rodgers & Smith 1995, 1997; Rodgers & Schwikert 2002, 2003), approach distance is an uncontrolled variable of vessel presence for studies that do not employ an experimental design.

#### *Responses of avian species to visual disturbance*

*Behavioral Response*— Studies documented a variety of avian behavioral responses to vessel disturbance, including altered behavior states and changes in social structure.

Visual disturbances associated with vessel presence were shown to cause increased alert behavior (Bamford et al. 1990; Galicia & Baldsarre 1991; Traut & Hosteler 2003), flight (Hume 1976; Korschgen et al. 1985; Bratton 1990; Kahl 1991; Havera et al. 1992; Pierce et al. 1993; Belanger & Bedard 1998; Knapton et al. 2000; Kenow et al. 2003; Traut & Hosteler 2003), swimming (Kenow et al. 2003), and a reduction in foraging (Kaiser & Fritzell 1984; Knight & Knight 1984; Galicia & Baldsarre 1997; Stolen 2003).

In one study, duck broods scattered in the presence of vessels (Keller 1991). Two studies showed that habituation (a stabilization of response over exposure time) of birds to vessel disturbance is possible (Burger & Galli 1987; Stolen 2003). Studies rarely modeled the potential impact of behavioral changes in a biologically meaningful way, making extrapolation of the potential impacts of such effects difficult.

Physiological responses of avian species to visual disturbance caused by vessels have not been reported in literature published to date. Instantaneous physiological measures may be a better indicator of bird responses to stimuli from vessel disturbance than visual observation. Knowledge of physiology will improve the ability to estimate energetic costs associated with vessel disturbance. Instantaneous physiological measures are retrievable from individual birds via radio telemetry technology (e.g., Ely et al. 1999).

*Demographic Response*— Demographic impacts reported by vessel disturbance studies include increased potential for predator encounters with offspring (Keller 1991) and increased mortality of offspring (Mikola et al. 1994). Less severe demographic consequences ranged from delayed arrival at breeding grounds due to increased foraging requirements (higher energy cost to avoid vessels) at migratory stopover sites (Schummer & Eddleman 2003), to a reduction in bird use of disturbed locations, measured as reduced abundance (Kaiser & Fritzell 1984; Bramford et al 1990; Kuletz 1996). Although demographic impacts have been quantified, little effort has been made to model the sub-

population or population level impact of vessel disturbance consequences for these species investigated.

*Responses of avian species to acoustic disturbance*

Only one study reported the potential impact of vessel sound on avian response, but a number of other studies provide insight on the effect of sound from other mechanized transportation modes (automobiles, airplanes, helicopters). Evaluating the findings from current literature on avian response to sound disturbance may be useful for developing future work to address the potential impact of acoustic disturbance from vessels on avian species.

*Behavioral Response*— Sound disturbance has been shown to cause behavioral responses ranging from none to altered behavior states. Habituation of birds to sound disturbance was detected in two studies (Conomy et al. 1998; Delaney et al. 1999). In another, diving intensity did not differ with the presence or absence of sound disturbance (Lacroix et al. 2003). Other studies concluded that behavior state changes in the presence of sound disturbance, such that birds fly (Brown 1990; Burger 1998; Ward et al. 1999) or become more alert (Grubb & King 1991; Conomy et al. 1998) in the presence of sound disturbance. To our knowledge, physiological responses of avian species to sound disturbance have not been investigated to date.

*Demographic Response*— Sound disturbance to birds has rarely been investigated in a demographic context, but where the ability to evaluate demographic impacts exists in the literature, results vary. The most severe demographic impact of sound disturbance to an avian species measured to date was reduction of breeding density (Reijnen et al. 1995). In contrast, a different study concluded that sound disturbance does not affect reproductive success or productivity (Delany et al. 1999). Two other studies reported conflicting results. Batten (1977) reports that acoustic disturbance caused reduction in bird abundance, while Lacroix et al. (2003) finds no effect.

## **Discussion**

Our evaluation of published data suggests that vessel disturbance studies are moving toward more rigorous study design. Future efforts to characterize and monitor the effects of vessels on birds should follow the requirements of criterion levels one or two as defined above. Thus far, most vessel disturbance studies have focused on the local spatial scale. However, studies have not adequately addressed the population consequences of the spatial context. In order to appropriately address the population consequences of the spatial scale under examination, it is important to structure the study design to encapsulate the scale of inference. Understanding the mechanisms by which vessel disturbance may affect all population scales should be a goal of future research. Future work will benefit from studies of marked individuals, as individuals are the

appropriate sampling unit to advance the understanding of mechanisms affecting population level processes.

The studies we reviewed did not use biological variables consistently in analyses to determine the effects of vessel disturbance on avian responses. We suggest that future inclusion of such variables will improve the quality of disturbance research. When evaluated, biological factors “species” and “season” were consistently found to be significant sources of variability in bird response to vessel disturbance. Other factors such as breeding stage and bird age did not show consistently significant effects across studies. Although inclusion of a suite of biological factors in future analysis will likely increase sample size demands to maintain statistical power, the exclusion of significant biological factors will reduce the value of study results of disturbance effects. In order of priority of inclusion and ease of collection, the biological factors “species”, “season”, and “breeding-stage” should be included in future studies whenever possible.

Due to the inconsistent inclusion of environmental factors across studies and the potential correlative nature of such factors, it is difficult to assess patterns in environmental factors that contribute to variability in behavioral and demographic responses of avian species to vessel disturbance. However, many studies that included environmental variables in their analyses did observe that factors such as weather, tide and habitat type contributed to variability in bird responses to vessel disturbance. In many cases environmental variables were recorded, but low sample size or low dispersion of the environmental

variables across the data set resulted in exclusion of the variables. Such exclusion can reverse study conclusions. Schueck and Marzluff (1995) report that the inclusion of weather variables as covariates in an analysis assessing the effects of human disturbance is essential to the final study results. They point out that using a blocking factor, a common procedure to reduce error variance, for season and time of day does not control for the variability attributable to weather. In order to improve the quality of vessel disturbance reporting, and insure that results are not confounded by exclusion of potentially influential variables, studies which can not control for environmental variables should include them in the analytical process.

We believe it is important to include vessel related variables in the analysis of vessel disturbance effects on avian species. Studies in the literature have not consistently reported such factors. This issue weighs heavily on the ability of managers to interpret existing studies regarding the likelihood of significant disturbance in areas of bird-vessel interaction. However, a number of studies do include vessel-related variables that provide useful information regarding the relative effects of vessels under different conditions of vessel type, speed, and size. Most studies that compare more than one vessel type reported that motorboats cause greater disturbance than non-motorboats. Vessel speed consistently affected birds, and higher speed caused greater disturbance than lower speeds.

Although many studies reported vessel size, only one study investigated a gradient of vessel size. Unfortunately, this study did not present dispersion of vessel size across vessel speeds, another co-varying vessel factor. For this reason, the influence of vessel size on the effect of vessel disturbance remains unknown. A model predicting relative disturbance potential with respect to vessel size would be useful when considering the potential for vessel disturbance of birds. When “flush distance”, also called approach distance, is not investigated as a dependent variable in experimental stimulus-response studies, approach distance is an equally important uncontrolled vessel-related variable. As such, approach distance is found to have significant influence over bird response to disturbance, with closer approach distance eliciting greater behavioral response (flight) than cases of vessels which pass birds from a greater distance.

Most studies published to date target behavioral responses to vessel disturbance rather than demographic responses. Although an understanding of the behavioral response of avian species to disturbance is useful, conclusions that simply restate the observed effects of vessels on bird behavior do not provide the type of information useful to managers who would like to ensure that decisions are not impacting a species ability to persist. Behavioral response studies can be advanced toward the goal of a greater understanding of demographic impact by using models to examine the effects of disturbance on the energy budget of a focal species, or to identify the effects of changes in the energy budget on species fitness.

Another approach uses behavioral response data to inform demographic response by modeling the trade-off between foraging and vessel disturbance of animals. Examining this trade-off provides an indication of the relative site use between disturbed and undisturbed sites (Gill et al. 1996). The behavioral effects are translated to impact by quantifying the biomass of unexploited food into the number of birds which may have been supported by the unused biomass in the absence of disturbance. This approach is not appropriate for species that rely on forage resources that are substantially heterogeneous in time and space.

Many behavioral ecologists are calling for the use of modeling as a problem-solving tool, to provide a scientific basis for deciding between alternative management options (Sutherland 1996; Starfield 1997; Clark and Mangel 2000; West et al. 2002; Beale & Monaghan 2004). There is a clear need for more studies at the demographic response level. As Gill et al. (2001) states, "Future studies need to address how behavioral changes in response to disturbance affect demographic parameters such as survival and reproductive success. This will also require an understanding of the strength of density-dependence within a system, in order to determine whether changes in survival or fecundity will have any impact on overall population size."

By reviewing the available literature on vessel disturbance of birds, it is apparent that great strides have been made to improve the scientific rigor of vessel disturbance reporting over time. It is apparent that vessel disturbance negatively affects birds and in



some cases may negatively impact bird fitness. However, many issues remain regarding the spatial scale and the inclusion of appropriate biological, environmental and vessel related variables in research efforts.

In summary, three primary classes of impacts have been identified.

- (1) A direct impact on offspring survival when vessels travel in proximity to swimming duck broods. Broods respond by scattering, increasing vulnerability to predation encounters (Keller 1991), and resulting in higher incidence of offspring mortality (Mikola et al. 1994).
- (2) A reduction in foraging behavior and an increase in energetically costly behavior, such as flight. Behavior changes can constitute energetic impact at high rates of vessel traffic (Korschgen et al. 1985; Schummer & Eddleman 2003).
- (3) A loss of suitable habitat, as vessel traffic can reduce bird use of vessel disturbed areas (Kaiser & Fritzell 1984; Bramford et al 1990).

Studies to date focus on the potential effects of visual disturbance caused by vessels, with few conclusions drawn regarding the effects of acoustic disturbance. In reality, bird response is likely triggered by a combination of visual and auditory stimuli, and an understanding of both classes of potential disturbance stimulus should be sought.

Table 1.1. The types of disturbance (acoustic and visual) and disturbance sources from the reviewed literature that is relevant to the discussion of vessel disturbance impacts on birds.

Disturbance source <sup>a</sup>	Number of papers <sup>b</sup>	
	Acoustic disturbance	Visual disturbance
Boat	1	32
Air	5	2
Automobile	1	1
Other	1	

<sup>a</sup> Papers may provide more than one disturbance classification, and/or response type, and/or impact source; therefore, some studies are enumerated more than once in the above table.

<sup>b</sup> Papers reviewed in our study were Batten 1977; Belanger & Bedard 1989; Bramford et al. 1990; Bratton 1990; Brown 1990; Burger 1998; Burger & Galli 1987; Conomy et al. 1998; Delaney et al. 1999; Galicia & Baldassarre 1997; Grubb & King 1991; Havera et al. 1992; Hume 1976; Kahl 1991; Kaiser & Fritzell 1984; Keller 1991; Kenow et al. 2003; Knapton et al. 2000; Knight & Knight 1984; Korschgen et al. 1985; Kuletz 1996; Lacroix et al. 2003; Mikola et al. 1994; Pierce et al. 1993; Reijnen et al. 1995; Robinson & Pollitt 2002; Rodgers & Schwikert 2002, 2003; Rodgers & Smith 1995, 1997; Ronconi & St Clair 2002; Schummer & Eddleman 2003; Stolen 2003; Titus & Vandruff 1981; Traut & Hostetler 2003; Tuite et al. 1984; Ward et al. 1999; Wood 1999.

Table 1.2. Biological variables included in analyses to determine the effects of vessel disturbance on birds.

Biological variables	Number of papers*
None	26
Species	11
Age	5
Breeding stage	4
Nesting vs. non-nesting birds	1
Brood age	1

\*Note that some of the thirty-eight papers evaluated include more than one biological variable in analysis, and are therefore counted more than once.

Table 1.3. Environmental variables analyzed in vessel disturbance studies.

Environmental variable(s)	Number of papers*
None	12
Time of Day	12
Season	11
Habitat Type	6
Tides	4
Habitat Features	3
Month (within Season)	3
Weather	3
Disturbance Activity Level	3
Location within Site	1
Year	1

\*Note that some of the thirty-eight evaluated papers include more than one environmental variable in analyses and are counted more than once.

Table 1.4. The relative effects attributed to vessel type for studies that compare effects of more than one vessel type.

Paper	Vessel type effect	Species
Rodgers & Smith 1997	Species specific response to vessel types motorboat and canoe	4 water-birds
Rodgers & Schwikert 2003	Airboat > disturbance than outboard motorboat	13 waterbirds
Grubb & King 1991	Kayak and canoe > disturbance than motorboat	Bald Eagle
Robinson & Politt 2002	Jet ski > disturbance than motorboat, rowboat, or windsurfer	water-birds
Havera et al. 1992	Motorboat > disturbance than barge	diving ducks
Titus & Vandruff 1981	Motorized canoe > disturbance than canoe	Common Loon
Rodgers & Schwikert 2002	Motorboat = to disturbance of Personal watercraft (PWC) for all species except Great Blue Heron, for which PWC > disturbance than motorboat	23 waterbirds
Burger 1998	PWC > disturbance than motorboat	Common Tern
Keller 1991	Motorboat > disturbance than rowboat or windsurfer	Eider ducklings
Tuite et al. 1984	Sailboat > Rowing > Canoe > Motorboating and waterskiing disturbance	10 waterfowl

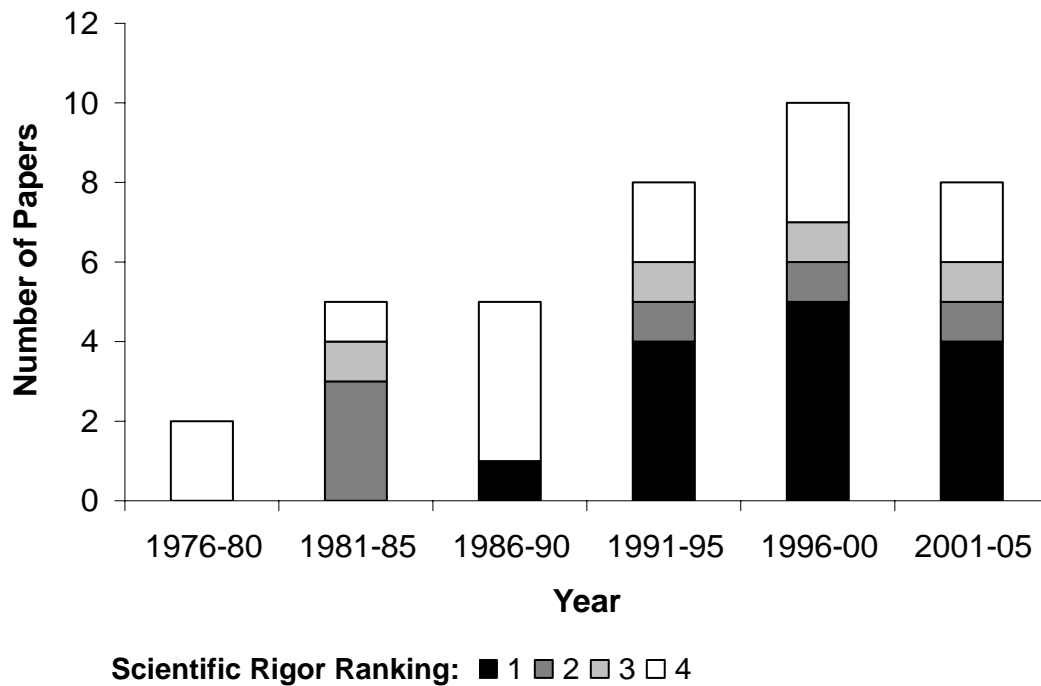

Figure. 1.1. Review of relevant disturbance literature, and the corresponding scientific rigor ranking (Hill et al. 1997), from 1976 to present.

## Notes to Chapter 1

- Batten, L.A. 1977. Sailing on reservoirs and its effects on water birds. *Biological Conservation* 11(1): 49-58.
- Beale, C.M. and P. Monaghan. 2004. Human disturbance: people as predation-free predators? *Journal of Applied Ecology* 41(2): 335-343.
- Belanger, L. and J. Bedard. 1989. Responses of Staging Greater Snow Geese to Human Disturbance. *Journal of Wildlife Management* 53(3): 713-719.
- Boyle, S.A. and F.B. Samson. 1985. Effects of Nonconsumptive Recreation on Wildlife - a Review. *Wildlife Society Bulletin* 13(2): 110-116.
- Bramford, A.R., S.J.J.F. Davies, and R. van Delft. 1990. The effects of model power boats on waterbirds at Herdsman lake, Perth, Western Australia. *Emu* 90:260-265.
- Bratton, S.P. 1990. Boat disturbance of Ciconiiformes in Georgia estuaries. *Colonial Waterbirds* 13: 124-128.
- Brown, A.L. 1990. Measuring the Effect of Aircraft Noise on Sea Birds. *Environment International* 16(4-6): 587-592.
- Burger, J. 1998. Effects of motorboats and personal watercraft on flight behavior over a colony of Common Terns. *Condor* 100(3): 528-534.
- Burger, J. and J. Galli. 1987. Factors Affecting Distribution of Gulls (*Larus* Spp) on 2 New-Jersey Coastal Bays. *Environmental Conservation* 14(1): 59-65.
- Carney, K.M. and W.J. Sydeman. 2000. "Response: Disturbance, habituation and management of waterbirds. *Waterbirds* 23(2): 333-334.
- Cincotta, R.P., J. Winewski, and R. Engleman. 2000. Human Population in the biodiversity hotspots. *Nature* 404: 990-992.
- Clark, C.W. and M. Mangel. 2000. *Dymanic State Variable Models in Ecology*. Oxford University Press, Oxford.
- Conomy, J.T., J.A. Dubovsky, J.A. Collazo, W.J. Fleming. 1998. Do black ducks and wood ducks habituate to aircraft disturbance? *Journal of Wildlife Management* 62(3): 1135-1142.

Delaney, D.K., T.G. Grubb, P. Beier, L.L. Pater, M.H. Reiser. 1999. Effects of helicopter noise on Mexican spotted owls. *Journal of Wildlife Management* 63(1): 60-76.

Ehrlich, P.R. and J. Holdren. 1971. "The impact of population growth." *Science* 171: 1212-1217.

Ely, C.R., D.H. Ward, and K. S. Bollinger. 1999. Behavioral correlates of heart rates of free-living Greater White-fronted Geese. *Condor* 101(2): 390-395.

Foster, J.T., E.J. Tweed, R.J. Camp, B.L. Woodworth, C.D. Adler, and T. Telfer. 2004. Changes of native and introduced birds in Alaka'i swamp, Kaua'i. *Conservation Biology* 18(3): 716-725.

Galicia, E. and G. A. Baldassarre. 1997. Effects of motorized tourboats on the behavior of nonbreeding American flamingos in Yucatan, Mexico. *Conservation Biology* 11(5): 1159-1165.

Gill, J.A., W.J. Sutherland, and A.R. Watkinson. 1996. A method to quantify the effects of human disturbance on animal populations. *Journal of Applied Ecology*. 33(4): 786-792.

Gill, J.A., K. Norris, and W. J. Sutherland. 2001. Why behavioural responses may not reflect the population consequences of human disturbance. *Biological Conservation* 97(2): 265-268.

Grubb, T.G. and R.M. King. 1991. Assessing Human Disturbance of Breeding Bald Eagles with Classification Tree Models. *Journal of Wildlife Management* 55(3): 500-511.

Hall, C.M. 2001. Trends in ocean and coastal tourism: the end of the last frontier? *Ocean and Coastal Management* 44: 601-618.

Havera, S.P., L.R. Boens, et al. 1992. Human Disturbance of Waterfowl on Keokuk Pool, Mississippi River. *Wildlife Society Bulletin* 20(3): 290-298.

Heckel, G., I. Espejel, and D.W. Fischer. 2003. Issue definition and planning for whale watching management strategies in Ensenada, Mexico. *Coastal Management* 31(3): 277-296.

Hill, D., D. Hockin, D. Price, G. Tucker, R. Morris, and J. Treweek. 1997. Bird disturbance: Improving the quality and utility of disturbance research. *Journal of Applied Ecology* 34(2): 275-288.



- Hockin, D., M. Ounsted, M. Gorman, D. Hill, V. Keller, and M.A. Barker. 1992. Examination of the Effects of Disturbance on Birds with Reference to Its Importance in Ecological Assessments. *Journal of Environmental Management* 36(4): 253-286.
- Hume, R.A. 1976. Reactions of Goldeneyes to boating. *British Birds* 69: 178-179.
- Kahl, R. 1991. Boating Disturbance of Canvasbacks During Migration at Lake Poygan, Wisconsin. *Wildlife Society Bulletin* 19(3): 242-248.
- Kaiser, M.S. and E.K. Fritzell. 1984. Effects of River Recreationists on Green-Backed Heron Behavior. *Journal of Wildlife Management* 48(2): 561-567.
- Keller, V.E. 1991. Effects of Human Disturbance on Eider Ducklings Somateria-Mollissima in an Estuarine Habitat in Scotland. *Biological Conservation* 58(2): 213-228.
- Kenow, K.P., C.E. Korschgen, J.M. Nissen, A. Elfessi, and R. Steinbach. 2003. A voluntary program to curtail boat disturbance to waterfowl during migration. *Waterbirds* 26(1): 77-87.
- Knapton, R.W., S.A. Petrie, and G. Herring. 2000. Human disturbance of diving ducks on Long Point Bay, Lake Erie. *Wildlife Society Bulletin* 28(4): 923-930.
- Knight, R.L. and S.K. Knight. 1984. Responses of Wintering Bald Eagles to Boating Activity. *Journal of Wildlife Management* 48(3): 999-1004.
- Korschgen, C.E., L.S. George, and W.L. Green. 1985. Disturbance of Diving Ducks by Boaters on a Migrational Staging Area. *Wildlife Society Bulletin* 13(3): 290-296.
- Kuletz, K.J. 1996. Marbled Murrelet Abundance and Breeding Activity at Naked Island, Prince William Sound, and Kachemak Bay, Alaska, before and after the *Exxon Valdez* Oil Spill. *American Fisheries Society Symposium* 18: 770-784.
- Lacroix, D.L., R.B. Lanctot, J.A. Reed, and T.L. McDonald. 2003. Effect of underwater seismic surveys on molting male Long-tailed Ducks in the Beaufort Sea, Alaska. *Canadian Journal of Zoology*. 81: 1862-1875.
- Mikola, J., M. Miettinen, E. Lehtikoinen, and K. Lehtila. 1994. The Effects of Disturbance Caused by Boating on Survival and Behavior of Velvet Scoter Melanitta-Fusca Ducklings. *Biological Conservation* 67(2): 119-124.
- Newton, I. 2004. The recent declines of farmland bird populations in Britain: an appraisal of causal factors and conservation actions. *Ibis* 146(4): 579-600.

- Nisbet, I.C.T. 2000. Disturbance, habituation, and management of waterbird colonies - Commentary. *Waterbirds* 23(2): 312-332.
- Norris, K., P.W. Atkinson, J.A. Gill. 2004. Climate change and coastal waterbird populations – past declines and future impacts. *Ibis* 146:82-98. Suppl. 1
- Pierce, G.J., C.J. Spray, E. Stuart. 1993. The Effect of Fishing on the Distribution and Behavior of Waterbirds in the Kukut Area of Lake Songkla, Southern Thailand. *Biological Conservation* 66(1): 23-34.
- Reijnen, R., R. Foppen, C. Terbraak, and J. Thissen. 1995. The Effects of Car Traffic on Breeding Bird Populations in Woodland .3. Reduction of Density in Relation to the Proximity of Main Roads. *Journal of Applied Ecology* 32(1): 187-202.
- Rivera J. 2004. Institutional pressures and voluntary environmental behavior in developing countries: Evidence from the Costa Rican hotel industry. *Society and Natural Resources* 17(9): 779-797.
- Robinson, J.A. and M.S. Pollitt. 2002. Sources and extent of human disturbance to waterbirds in the UK: an analysis of Wetland Bird Survey data, 1995/96 to 1998/99. *Bird Study* 49: 205-211.
- Rodgers, J.A. and S.T. Schwikert. 2002. Buffer-zone distances to protect foraging and loafing waterbirds from disturbance by personal watercraft and outboard-powered boats. *Conservation Biology* 16(1): 216-224.
- Rodgers, J.A. and S.T. Schwikert. 2003. Buffer zone distances to protect foraging and loafing waterbirds from disturbance by airboats in Florida. *Waterbirds* 26(4): 437-443.
- Rodgers, J.A. and H.T. Smith. 1995. Set-Back Distances to Protect Nesting Bird Colonies from Human Disturbance in Florida. *Conservation Biology* 9(1): 89-99.
- Rodgers, J.A. and H.T. Smith. 1997. Buffer zone distances to protect foraging and loafing waterbirds from human disturbance in Florida. *Wildlife Society Bulletin* 25(1): 139-145.
- Ronconi, R.A. and C.C. St Clair. 2002. Management options to reduce boat disturbance on foraging black guillemots (*Cepphus grylle*) in the Bay of Fundy. *Biological Conservation* 108(3): 265-271.
- Schueck, L.S. and J.M. Marzluff. 1995. Influence of Weather on Conclusions About Effects of Human Activities on Raptors. *Journal of Wildlife Management* 59(4): 674-682.

- Schummer, M.L. and W.R. Eddleman. 2003. Effects of disturbance on activity and energy budgets of migrating waterbirds in south-central Oklahoma. *Journal of Wildlife Management* 67(4): 789-795.
- Sisk, T.D., A.E. Launer, K.R. Switky, and P.R. Ehrlich. 1994. Identifying extinction threats. *Bioscience* 44:592-603.
- Starfield, A.M. 1997. A pragmatic approach to modeling for wildlife management. *Journal of Wildlife Management*. 61(2): 261-270.
- Stolen, E.D. 2003. The effects of vehicle passage on foraging behavior of wading birds. *Waterbirds* 26(4): 429-436.
- Sutherland, W.J. 1996. *From Individual Behaviour to Population Ecology*. Oxford University Press, Oxford.
- Titus, J.R. and L.W. Vandruff. 1981. Response of the Common Loon to Recreational Pressure in the Boundary Waters Canoe Area, Northeastern Minnesota." *Wildlife Monographs* 79: 6-58.
- Traut, A.H. and M.E. Hostetler. 2003. Urban lakes and waterbirds: Effects of development on avian behavior. *Waterbirds* 26(3): 290-302.
- Tuite, C.H., P.R. Hanson, and M. Owen. 1984. Some Ecological Factors Affecting Winter Wildfowl Distribution on Inland Waters in England and Wales, and the Influence of Water-Based Recreation. *Journal of Applied Ecology* 21(1): 41-61.
- Ward, D.H., R.A. Stehn, W.P. Erickson, and D.V. Derksen. 1999. Response of fall-staging brant and Canada geese to aircraft overflights in southwestern Alaska. *Journal of Wildlife Management* 63(1): 373-381.
- West, A.D., J.D. Goss-Custard, R.A. Stillman, R.W.G. Caldow, S.E.A.L.D. Durell, and S. McGrorty. 2002. Predicting the impacts of disturbance on shorebird mortality using a behaviour-based model. *Biological Conservation* 106(3): 319-328.
- Wood, P.B. 1999. Bald Eagle Response to Boating Activity in Northcentral Florida. *Journal of Raptor Research* 33(2): 97-101.

## **Chapter 2: Effects of vessel activity on the near shore ecology of the Kittlitz's Murrelet (*Brachyramphus brevirostris*) in Glacier Bay, Alaska**

### **Summary**

Summer breeding populations of Kittlitz's Murrelets have declined by 80-90% in Southeast Alaska over the past 10-25 years. Sources of mortality (oil spills and gillnet bycatch) known from other locations, are not frequent or extensive enough in Glacier Bay to fully explain the observed declines. Vessel activity overlaps in space and time with the species in foraging areas in Glacier Bay, Alaska. Vessels could affect the Kittlitz's Murrelet on foraging grounds by causing them to fly away from preferred foraging sites, or by disrupting foraging bouts, resting periods or chick meal foraging trips. We used observation methods to investigate the effect of vessel activity on Kittlitz's near shore density, group dynamics, and behaviors. Three time scales of inference (immediate, individual vessel event, and daily) were used to assess effects. Group dynamics were not affected by vessel activity at any time scale of inference, but near shore density and behaviors were affected. Negative effects on near shore density (decline in density post disturbance) were temporary, and not detected at the daily time scale. Therefore, vessel activity does not constitute a loss of suitable habitat for the Kittlitz's Murrelet. Density recovered soon after vessel events. Behavior was affected at both the immediate and daily time scales, but not detected at the individual event time scale. Behavioral change attributed to vessel activity may constitute impact, by increasing flight, an energetically costly behavior. Variability in behavioral response caused by vessel factors (size, speed,

approach distance) has implications for management of vessel activity in sensitive wilderness areas.

## **Introduction**

Increasingly, species and populations of birds are at risk in a conservation context because of anthropogenic and climate changes leading to habitat loss and degradation, among other reasons (i.e. Newton 2004, Norris et al. 2004). Ecotourism is an active sector of human economies. Wild terrestrial and marine coastal habitats which may have remained remote and inaccessible until very recently are being explored through ecotourism. Watercraft use often accompanies ecotourism for recreational travel in ecologically sensitive places (Hall 2001). Marine species likely experience unprecedented levels of disturbance, and may face conservation challenges as a result. One such species is the seabird, Kittlitz's Murrelet (*Brachyramphus brevirostris*).

Glacier Bay National Park supports perhaps a quarter of the world population of Kittlitz's Murrelet during the summer breeding season. Survey data collected during the summer from two core population areas in Alaska (Glacier Bay and Prince William Sound) indicate declines of 80-90% in the past 10-25 years (Drew and Piatt, *in prep*, Robards et al. 2003, Kuletz, *in press*). Currently, the Kittlitz's Murrelet is a candidate species for listing under the U.S. Endangered Species Act. Possible causes of the species decline include changes in food supply, changes in climate affecting food supply, loss of habitat

from glacial recession, winter mortality, and vessel disturbance in core foraging areas. Oil spills and gillnet mortality are well documented causes of mortality to the species in other areas (Wynne et al. 1992, van Vliet 1993, van Vliet and McAllister 1994, Day et al. 1999). Because the obvious anthropogenic sources of mortality are either absent from Glacier Bay (gillnet fishing, Dept. of Interior 1991), or not large enough to account for recent population declines (oil spills, Eley 2000), undocumented factors likely contribute to the overall population decline.

Glacial waters near or at tidewater glaciers and the outflow of glacial streams are preferred forage habitat of the Kittlitz's Murrelet in glaciated areas of Southeast Alaska (Bailey 1927, Kuletz 1989, Kuletz and Piatt 1992, Piatt et al. 1994, Day and Nigro 2000, Day et al. 2003). Although the species prefers glacial habitat on a large scale, they will forage in unglaciated areas (Day et al. 1999, Piatt unpubl. data). The benefits of foraging in glacial waters are not known. The observation that glacial waters are commonly used, however, indicates a likely benefit such as increased foraging success or possibly energy conservation for adult breeders during nesting, because nesting occurs on recently deglaciated terrain close to glacial waters (Day et al. 1999).

During the northern summer season, Glacier Bay National Park (GBNP) is a major tourism destination (442,607 visitors in 1999, GBNP unpubl. data) in Southeast Alaska. Most visitors to Glacier Bay National Park tour the park via cruise ship (75-84% of visitation, 1980 - 1992, GBNP unpubl. data). Presently (2005), two cruise ships and four

large tour boats are permitted to enter park waters each day through the summer season (late May – late September). Up to 25 private recreational motor-vessels are also permitted to tour the park per day from 1 June through 31 August. Tidewater glaciers in Glacier Bay are a major draw for tourists and consequently attract vessel activity. Vessel activity, therefore, overlaps in space and time with the murrelets in their usual foraging areas, which is cause for concern in light of the reported population declines. Vessels could affect Kittlitz's on their foraging grounds by causing them to fly away from preferred foraging sites or by disrupting foraging bouts, resting periods or chick meal foraging trips.

We characterized the effects of vessel activity on Kittlitz's Murrelet near shore density, group dynamics and behaviors. An effect causes the response variable under investigation to change in the presence of vessels. Although the biological importance of significant effects is unknown, defining effects is the first step to understand severity or magnitude of change and implications for biological importance. We investigated three hypotheses: (1) vessel activity causes decline in near shore density; (2) vessel activity causes change in group dynamics; and (3) vessel activity causes change in behaviors at sea.

An additional consideration for our third hypothesis (vessel activity causes change in behaviors) was breeding status of the murrelets. Chick rearing has a high energetic cost for Kittlitz's, because nest sites are known to be up to 75 km inland (Day et al. 1983).

They also use a muscle powered flight strategy that is energetically costly (Pennycuick 1987). For these reasons, we hypothesized that murrelets engaged in chick provisioning have different behavioral responses to vessel activity than those not engaged in provisioning. Murrelets hold a single fish cross-wise in the bill for later delivery to chicks (Carter & Sealy 1987, Strachan et al. 1995). Thus fish-holding behavior indicates that murrelets are rearing chicks. We also divided our third hypothesis to consider change in behavior of fish-holding Kittlitz's Murrelets separately from non fish-holding Kittlitz's Murrelets.

## **Methods**

Three types of field sampling were employed to address our objectives: (1) presence and absence vessel activity sampling; (2) before and after vessel activity sampling; and (3) during vessel activity sampling. We observed density, group dynamics and behaviors both before and after vessel activity and in the presence and absence of vessel activity with area scan and focal bird sampling techniques (Altman 1974). We observed our ecological parameters during vessel activity with a method similar to stimulus-response sampling (Rodgers and Schwikert 2002). Observations were made at seven sites in Glacier Bay, and sampling occurred across available daylight hours (n= 41 days, 9-11 h/day) (Figure 2.1). Sites were selected based on known Kittlitz's occurrence evident from boat and air-based survey efforts characterizing their density in previous years (Bodkin et al. 2001, Piatt unpubl. data). Four of the observation sites were characterized



by glacial habitat (near tidewater glacier or glacier stream input), and three sites were characterized by non-glacial habitat (no glacial influence) (Figure 2.1). All sampling was conducted within designated near shore areas ( $\bar{x}$  area:  $3.44 \pm 0.52 \text{ km}^2$ ).

One observer and one primary recorder conducted observations from land in the designated near shore areas. We observed with a telescope and binoculars, and dictated data to recorders. Recorders used Palm m150 (Palm, Sunnyvale, CA) handheld devices to record data. We created behavioral software specifically for our sampling protocols. Additional data collected were time of day, Beaufort state and rain (Table 2.1). When Beaufort state was greater than two, sampling ceased due to the heightened difficulty of observing murrelets. We generated tide state and current data using Tides and Currents (Nobeltec, Beaverton, OR) software (Table 2.1). We also estimated breeding phenology stage for concurrent sampling using methodology described by Agness (Appendix 1).

*Before/After & Presence/Absence Sampling* – We sampled on half-hour intervals to characterize our response variables before and after vessel activity. Area scans were conducted each half-hour with mean duration of 12 minutes. Focal bird samples were conducted between area scans. Each focal sample took five minutes, and up to three focal samples could be collected in a half-hour. During area scans, all murrelets were counted, and data were collected on species (Kittlitz's Murrelets, Marbled Murrelets, or unidentified murrelet), group size and behavior (loafing, diving, flying, fish-holding, and flying while fish-holding). Group size and behavior data were instantaneous measures.

Murrelet groups were defined as singles, pairs, and flocks. A flock of murrelets was defined as three or more birds in close proximity that maintain formation during movement or activity (Strachan et al. 1995). For focal bird samples, a group was selected at random, and up to two individuals within the group were followed for the five-minute period. We recorded data on species identification and time spent in group sizes and behaviors. A ‘before’ scan or focal sample occurred within 30 minutes prior to a vessel activity event in the designated observation area. An ‘after’ scan or focal sample occurred within 30 minutes following a vessel activity event. All scans collected in the absence of vessel activity were called ‘absence’ scans, and scans conducted during vessel activity (stimulus-response scans) were called ‘presence’ scans (see following section). Vessel activity events were collected opportunistically during this study, defined by vessel movement in an observation area.

*During Vessel Activity Sampling* – Two methods of sampling were employed: (1) land-based observation of murrelet responses to vessel activity in observation areas, and (2) ship-board observation of murrelet responses to the focal vessel across observation areas. Land-based observation started when active vessels entered observation areas. When this happened, we stopped other sampling (scan or focal), and began stimulus-response sampling. As a vessel moved through the observation area, loafing murrelets to either side and in front of the vessel (up to 1000 m) were watched by the land-based observer. If murrelet behavior changed as the vessel approached, we recorded the approach distance (distance between the vessel and bird) of the behavioral response, the change in

behavior (dive or fly), and species identification. We also collected data on the vessel (speed and size). If murrelet behavior did not change as the vessel approached, we recorded the closest distance between the vessel and murrelet, and ‘loafing’ behavior, or no response. Stimulus-response observations conducted from a vessel used the same methodology, except observers watched from the vessel. Ship-board observations were conducted to supplement land-based efforts, and increase the sample size for vessel factors (speed and size) that were under-represented by our opportunistic land-based effort.

Approach distance estimates were calibrated among members of the observation team. We used a range finder (Bushnell, Overland Park, KS, USA) to test our distance estimation ability from vessel to shore at varying distances. After vessel to shore calibration, we were able to estimate approach distances for murrelets from a vessel with accuracy. A vessel-based observer and a land-based observer next communicated by hand-held radios to calibrate distance estimation from land. Trial vessel activity events were initiated, and we rotated observers on board a vessel and on land. During trial runs, for each murrelet encountered, an approach distance was called by the vessel-based observer, and confirmed by the land-based observer. Using this technique, we were able to estimate approach distance from land proficiently over time. We estimated approach distances in three distance categories (Table 2.2).

Vessel size and speed estimates were also calibrated with known measures. During observer training, we made VHF radio contact with operators running vessels of varied sizes in the area. We asked for confirmation on running speed and vessel size. We also used our own vessel (6 m Naiad inflatable) to test speeds. With practice, we could estimate both vessel size and speed proficiently. Our speed and size measures were recorded in categories. Vessel size was recorded in five categories, and vessel speed in three categories (Table 2.2).

*Analytical Methods*— Two time scales were used to test the effects of vessel activity on near shore density and group size: individual and daily time scales. For our behavioral response variables, we tested three time scales including individual, daily and immediate vessel activity time scales. Cross-correlation plots (SYSTAT 7.0) confirmed independence of daily scan and focal series. Our sampling unit was therefore an individual scan or focal sample. We assigned species identification (Kittlitz's or Marbled Murrelet) to unidentified murrelets by multiplying the number of unidentified murrelets in a given scan by the proportion of each identified species (where identified species proportions sum to one), and added these numbers to the identified species counts. On average, the unidentified species count made up a small proportion of total murrelets per scan.

We evaluated the individual time scale with before and after sampling. To investigate density, group size and behavioral effects, we paired these parameters 30 minutes

‘before’ and ‘after’ individual vessel activity events. We tested the significance ( $\alpha=0.05$ ) of the mean response variable (as difference and proportion) with paired t-tests (SPSS, 12.0). Difference values less than zero indicated an increase in the response variable post-vessel activity, and values greater than zero indicated a decrease in the response variable post-disturbance. Proportion values less than one showed a decrease in response to vessel activity, and values greater than one showed an increase in response.

The daily time scale incorporates scan sampling for the response variables density and group size, and focal sampling for the behavior response variables. We used a daily vessel activity rate (vessels/h) to capture variation in vessel activity at the daily time scale. Only data from full sampling days ( $\geq 9$  h,  $n=36$  days) were used to ensure that vessel rate accurately reflected daily vessel activity. We additionally incorporated likely sources of variability in our response variables at a daily time scale (Table 2.1).

We modeled the effect of potentially influential variables at the daily time scale with regression trees. Regression tree analytical methods followed those of De’ath and Fabricus (2000) and De’ath (2003). We used univariate regression tree analysis (SPLUS, 7.0) for the response variables density and group size (De’ath and Fabricus 2000), and multivariate regression tree analysis (The R Foundation for Statistical Computing, R, 2.1.1) for behavioral response variables (De’ath 2003). Our behavioral response variables are the proportion of Kittlitz’s engaged in behavior states during scan samples, and the proportion of time individuals engaged in behaviors during focal samples. We

used multivariate statistics to evaluate behavior variables, because of the intra-dependence of these variables. Values for each behavior state in a given sampling unit sum to one.

For each model run, the measure of impurity that defined splitting criteria was sums of squares. The deviance explained by a node, therefore, is the sums of squares of the mean per node, and overall deviance is the sum across all leaves (De'ath and Fabricus 2000). We used ten-fold cross-validation techniques, and the 1-SE rule to determine the 'best' tree size (De'ath and Fabricus 2000, Breiman et al. 1984). Each model was run 50 times, and the modal 'best' tree size was chosen (De'ath and Fabricus 2000). In regression tree analysis, the importance of explanatory variables is indicated by the split number, or branch location. Branches closer to the terminal node represent more important predictor variables than branches further toward the tree "leaves".

We investigated the immediate time scale effects with presence and absence vessel activity sampling. For 'absence' scans, we used all behavioral proportion data from scans conducted in the absence of vessels, and for 'presence' scans, we used all behavioral proportion data from stimulus-response scans conducted during vessel activity. Mood's Median test (SPSS, 12.0) was used to evaluate whether behaviors in the absence of vessels were significantly different ( $\alpha= 0.05$ ) from to behaviors in the presence of vessels. We used multivariate regression tree analysis to evaluate response at the immediate time scale, because we also wanted to understand how vessel variables (speed,

size, and approach distance) contributed to variation in their immediate behavioral responses to vessel activity (Table 2.2). All variables included in analyses of the daily time scale (with the exception of vessel rate) were also included in regression tree analysis for immediate time scale effects.

## Results

*Near shore Density*-. At the individual time scale, sixty-two paired scans were available to assess whether density ('before' vs. 'after') declined post vessel event. We supported the hypothesis that vessel activity caused decline in near shore density at the individual event time scale ( $\bar{x}$  test values: difference=  $2.79 \pm 1.29$ ,  $t= 2.16$ ,  $df= 61$ , 1-tailed  $p= 0.0017$ ; proportion=  $0.40 \pm 0.12$ ,  $t= -5.75$ ,  $df=61$ ,  $p< 0.0001$ ).

The effects of daily vessel activity (daily time scale) were explained with our 'best' regression tree model. The model shows that vessel rate helped predict Kittlitz's density ( $R^2= 0.3$ ; Figure 2.2). Daily vessel rate was a more important predictor variable during the evening hours (2<sup>nd</sup> split), than during the morning and mid-day hours (5<sup>th</sup> split). The same pattern held regardless of time of day, however, such that when the vessel rate was none or low, murrelet density was lower, and when vessel rate was moderate or high, density was greater (Figure 2.2). Our data failed to support the hypothesis. Vessel activity did not cause decrease in near shore densities at the daily time scale.

We evaluated the effects of natural environmental and biological factors to variability in density by excluding vessel rate from the regression tree analysis ( $R^2 = 0.2$ ; Figure 2.3). The greatest Kittlitz's Murrelet densities occurred during morning and mid-day hours ( $\bar{x} = 6.5$  Kittlitz's/km<sup>2</sup>; n= 706 scans), during spring tides ( $\bar{x} = 17.2$  Kittlitz's/km<sup>2</sup>; n= 35 scans), and during the egg-lay breeding stage ( $\bar{x} = 73.6$  Kittlitz's/km<sup>2</sup>; n= 13 scans) (Figure 2.3). The lowest densities occurred during the evening hours ( $\bar{x} = 2.5$  Kittlitz's/km<sup>2</sup>, n= 198 scans), during neap and transition tide magnitude levels ( $\bar{x} = 2.1$  Kittlitz's/km<sup>2</sup>; n= 182 scans), during higher-high and low tide states ( $\bar{x} = 1.7$ , n= 141 scans), and during ebb and slack current states ( $\bar{x} = 1.0$ ; n=81 scans) (Figure 2.3).

*Group Dynamics*-. Effects on group dynamics at the individual event time scale were addressed with the same paired scan sampling approach used to examine individual event time scale effects on near shore density. Our data failed to support the hypothesis. Vessel activity did not change group dynamics at the individual event time scale (difference test value:  $t = 0.653$ ,  $df = 61$ , 2-tailed  $p = 0.561$ ).

Regression tree analysis showed that daily vessel rate was not a good predictor of group size, because vessel rate was not selected as a branching predictor variable in the 'best' model of group dynamics ( $R^2 = 0.48$ ; Figure 4). Thus, our data failed to support the hypothesis, and we concluded that vessel activity did not change group dynamics at the daily time scale. The analysis does provide information about variables that predicted important variation in group size, including species identity. Kittlitz's and Marbled



Murrelet groupings were similar, and both single species group patterns were smaller than mixed groups, which consist of groups with both species. Additionally, breeding stage (2<sup>nd</sup> split) and tidal magnitude (3<sup>rd</sup> split) were important predictors of murrelet group size (Figure 4).

*Behaviors*— At the immediate time scale we found that Kittlitz’s Murrelets changed behaviors in the presence of vessels, such that the proportion of the species engaged in flight increased (Mood’s Median  $\chi^2 = 102.6$ ,  $df = 1$ ,  $p < 0.0001$ ), and the proportion engaged in loafing decreased (Mood’s Median  $\chi^2 = 325.9$ ,  $df = 1$ ,  $p < 0.0001$ ) (Figure 5). Diving behavior did not immediately change in the presence of vessels (Mood’s Median  $\chi^2 = 1.160$ ,  $df = 1$ ,  $p = 0.322$ ).

We additionally considered vessel related factors which likely contributed to variation in immediate response to vessel activity (vessel size, speed, and approach distance) with multivariate regression tree analysis. We continued to use all environmental and biological variables included in other regression analyses except daily vessel rate. We also evaluated variation in immediate response of fish holding Kittlitz’s (indicating the chick-rearing stage) separate from non-fish holders.

Non fish-holders had greater flight response ( $\bar{x}$  proportion of Kittlitz’s: 0.55) from cruise ships and tour boats, than from small, medium, or large recreational vessels (mean proportion of Kittlitz’s: 0.26). Vessel size was the only split included in the ‘best’

regression model for non fish-holders ( $R^2 = 0.10$ ; Figure 6). Fish-holders had the greatest flight response ( $\bar{x}$  proportion of Kittlitz's: 0.54) from slow vessels with 'far' (400-1000 m) approach distance ( $R^2 = 0.50$ ; Figure 7). The mean flight response of Kittlitz's Murrelets to vessels of fast or medium speed, however, was very low ( $\bar{x}$  proportion of Kittlitz's: 0.01). Fish-holders most commonly engaged in dive behavior while holding a fish across all predictor variable splits (vessel speed, approach distance, and vessel size) included in the 'best' model (Figure 7). Variables other than vessel related factors (i.e. biological and environmental) were not found in the "best" regression models, and therefore did not influence variability in the behavioral response of fish holders or non-fish holders during vessel activity.

We next tested the individual event time scale using the paired scan approach ( $n=62$ ), and paired t-test (difference). Vessel activity did not change behaviors at the individual event time scale (loafing:  $t = -0.012$ ,  $p = 0.983$ ; diving:  $t = -0.109$ ,  $p = 0.914$ ; flying:  $t = 1.357$ ,  $p = 0.180$ ).

We tested behavioral effects at the daily time scale with multivariate regression tree analysis. Focal bird data were used to prevent under-representation of less frequent or prolonged behavioral states. The 'best' regression tree model included daily vessel rate as the second of two splits accounting for variability in behaviors. The data supported the hypothesis that vessel activity caused change in behaviors at the daily time scale.

Individuals spent more time diving, and less time loafing when daily vessel rate was low,

moderate, or high (Figure 8). Conversely, when there was no vessel traffic (vessel rate = 0), individuals spent more time loafing and less time diving (Figure 8). The other important variable influencing variation in behaviors was breeding phenology stage (Figure 8). All other variables included in regression analysis did not contribute to the variation in behaviors, as shown by exclusion from the ‘best’ model ( $R^2 = 0.2$ ).

## Discussion

We determined that individual vessel events caused significant declines in Kittlitz’s Murrelet near shore densities, and that the magnitude of decline was substantial ( $\bar{x}$  decline of 2.79 Kittlitz’s/km<sup>2</sup>; or  $\bar{x}$  of 40% decline in total Kittlitz’s). Because vessel activity did not cause declines in densities at the daily time scale, Kittlitz’s near shore density was only temporarily disturbed by vessel activity (Table 2.3). The murrelets likely returned to the disturbed areas over short time periods, since negative effects were not detected at the daily time scale. In fact, the opposite was found. Vessel activity was positively related to murrelet density at the daily time scale, regardless of other predictor variable interactions. Although Kittlitz’s likely moved some distance to accommodate vessel traffic, movements were temporary and resulted in an overall influx of Kittlitz’s to the near shore systems observed for unknown reasons. Other studies suggest that vessel traffic can cause loss of suitable habitat if bird use of areas disturbed by vessels is reduced (Kaiser & Fritzell 1984; Bramford et al 1990). We suggest that vessel activity

does not constitute a loss of suitable habitat for the Kittlitz's Murrelet, however, because density rebounded over the course of a day.

We did not detect effects of vessel activity on the group size of Kittlitz's Murrelets at individual event or daily time scales (Table 2.3). Social dynamics were not affected by vessel activity. Social dynamics, such as group size, may be important to foraging success in murrelets. For instance, it is thought that the Marbled Murrelet uses a cooperative foraging strategy, whereby a small group (typically 2) can herd a school of fish underwater to increase the time schools remain available as prey (Strachen et al. 1995, Speckman et al. 2003). Kittlitz's Murrelet foraging ecology is likely similar to the closely related Marbled Murrelet. It is likely that foraging capabilities of Kittlitz's are not detrimentally influenced by vessel activity, because the social structure of groupings remained intact regardless of vessel disturbance.

Although Kittlitz's Murrelet behavior was not influenced at short time scales after individual events, the cumulative effects of vessel events over a day led to increased diving behavior (Table 2.3). Increased diving may help Kittlitz's regain energy lost via flight during vessel activity if diving results in foraging success. Muscle-powered flight of the species is highly energetically costly (Pennycuick 1989). It is unknown whether increased diving activity on days with heightened vessel activity will alleviate the energetic cost of immediate flight response from vessel events. Although, Kittlitz's increased diving effort on days with vessel activity by a factor of three ( $\bar{x}$  increase in

proportion of time from 0.04 to 0.12), flying effort during vessel activity increased by more than thirty-fold ( $\bar{x}$  increase from 0% to 30% of birds). It is likely that Kittlitz's Murrelets have a net energy loss as a consequence of vessel activity. Species impacts can occur when vessel activity causes reduced foraging behavior and increased energetically costly behavior, such as flight. Other studies show that such behavioral changes can constitute energetic impact at high rates of vessel traffic (Korschgen et al. 1985; Schummer & Eddleman 2003). Chapter 3 will address the energetic cost of behavioral effects depicted here, with the objective to address the impact, or biological importance, of behavioral changes attributed to vessel activity.

Management implications may also apply to the vessel-related factors (speed and size) that caused variability in behavioral changes during vessel activity. For instance, the fact that variability in non-fish holder flight response was primarily influenced by vessel size (probability of flight > from cruise ships and tour boats, than from other vessel sizes) may have implications for the management of vessel quotas (i.e. restrictions or limits of certain sized vessels) in areas inhabited by the Kittlitz's Murrelet.

We suggest that fish-holders are highly invested in their behavior prior to the onset of vessel activity. The typical prior behavior is loafing with the held fish. Fish-holders generally do not deviate from loafing behavior until flight is initiated to bring the fish to their inland nest (Carter & Sealy 1987). Fish-holders are also more heavily wing-loaded by the held fish (~10g fish weight, Montevecchi and Piatt 1987). The combination of

high investment in loafing, and greater flight lift-off cost (due to fish weight) likely influences the low flight probability of fish-holders under most vessel conditions, with the exception of slow vessels with 'far' approach. Flight probability may be greater under slow speed and 'far' approach distance conditions, because fish-holders have more time to react to the slow, distant vessel activity, than to faster or closer activity. We consider reaction time important, because fish-holding murrelets may have a difficult time initiating flight, due to the additional fish weight. Our finding may have implications for the management of vessel speed (i.e. speed limits) in areas inhabited by the Kittlitz's Murrelet.

Behavioral effects other than flying were detected in fish-holders. They also dove with the held fish in response to vessel activity. We did not observe diving behavior by fish-holders when vessels were absent. Dive behavior for fish-holders could be energetically costly, with unknown consequences for chick provisioning. Limited warning of vessel approach (under high speed conditions) may make dive response the only prudent option. Further study should target individual fish-holders during vessel activity, follow their post vessel activity behavior, and determine whether diving results in the loss of the held fish, or premature flight to the nest. A study of the Marbled Murrelet by Speckman et al. (2004) found that small boats caused fish-holders to dive and then eat their held fish after repeated vessel approach. If fish-holders commonly eat fish following dive response from vessel traffic, the biological impacts could be significant to both the adult murrelet

that expends additional energy to catch another fish and for their chick if a meal is not delivered.

Table 2.1. Sources of variability included in daily time scale analysis which potentially influence the response variables (density, group size, and behaviors).

Variable	Description
Tide height state	Higher-high, High, Lower-low, Low
Tide current state	Ebb, Slack, Flood
Beaufort state	0, 1, 2
Rain	Yes, No
Near shore habitat type	Glacial (four most northwesterly sites in Fig. 1), Non-glacial (three most southeasterly sites in Fig. 1)
Time of day	Morning (0400-0900), Mid-day (0900-1800), Evening (1800-2300)
Breeding phenology stage	Egg-lay, Chick-rear, Fledge
Vessel rate (vessels/hr)	None (0.00), Low (0.01-0.30), Moderate (0.31-0.60), High (0.61-1.5)



Table 2.2. Vessel variables included in immediate time scale analyses.

Variable	Description
Vessel Speed	Slow (0-16 km/h), Moderate (17-32 km/h), Fast (33-48 km/h)
Vessel Size	Small (0-6 m), Medium (6-18 m), Large (18-27 m), Tour boat (30-49 m), Cruise ship (305+ m)
Approach Distance	Close (0-100 m), Moderate (100-400 m), Far (400-1000 m)

Table 2.3. Summary of hypothesis tests for the response variables at each time scale.

Response Variable	Time Scale	Test Results
Density	Individual	Density decreased
	Daily	No effect
Group dynamics	Individual	No effect
	Daily	No effect
Behaviors	Immediate	Flying increased
	Individual	No effect
	Daily	Diving increased

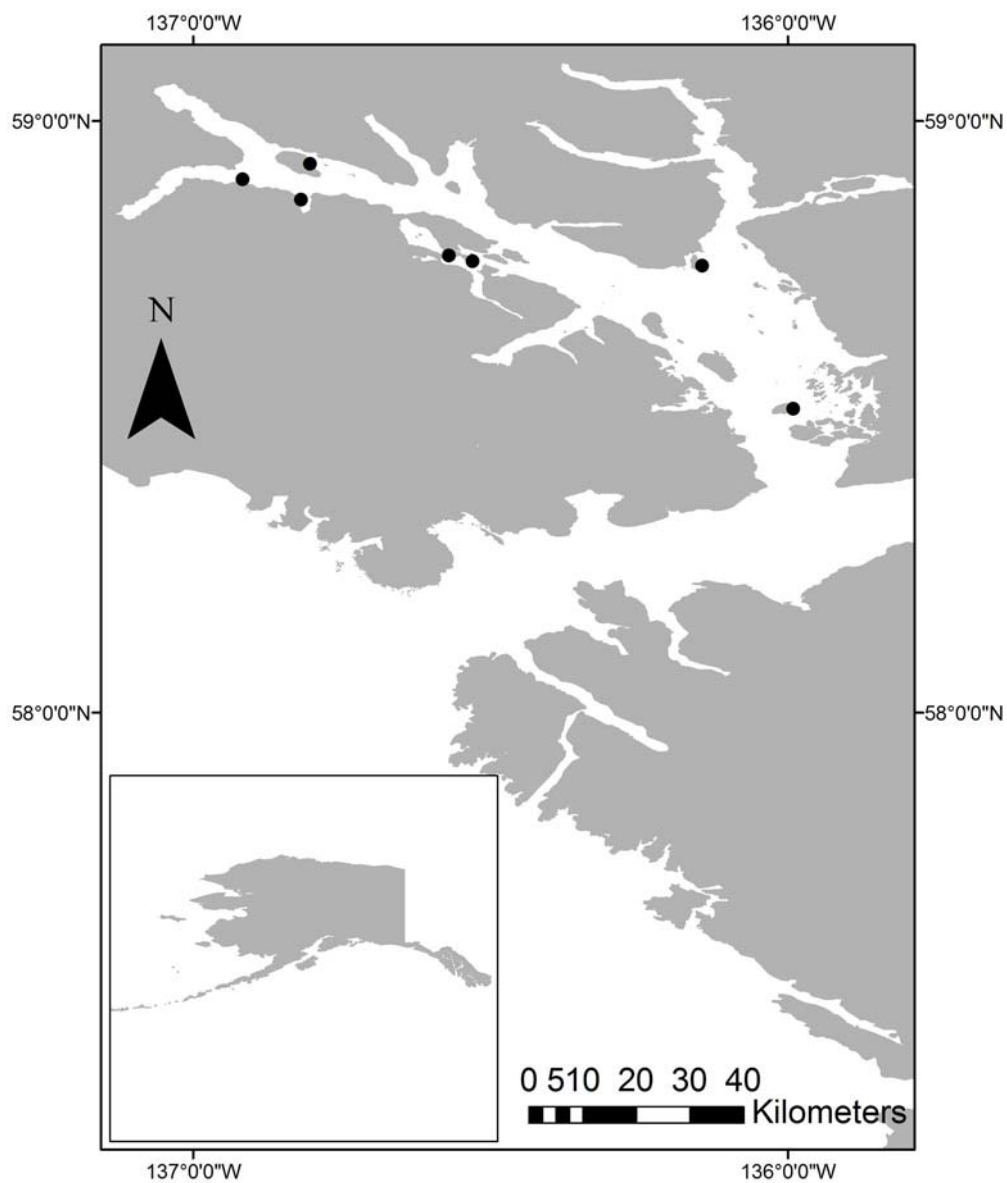

Figure 2.1. Location of field sites in Glacier Bay, Alaska, denoted with black circles. The four sites furthest to the northwest were glacial, and the three remaining sites to the southeast were non-glacial.

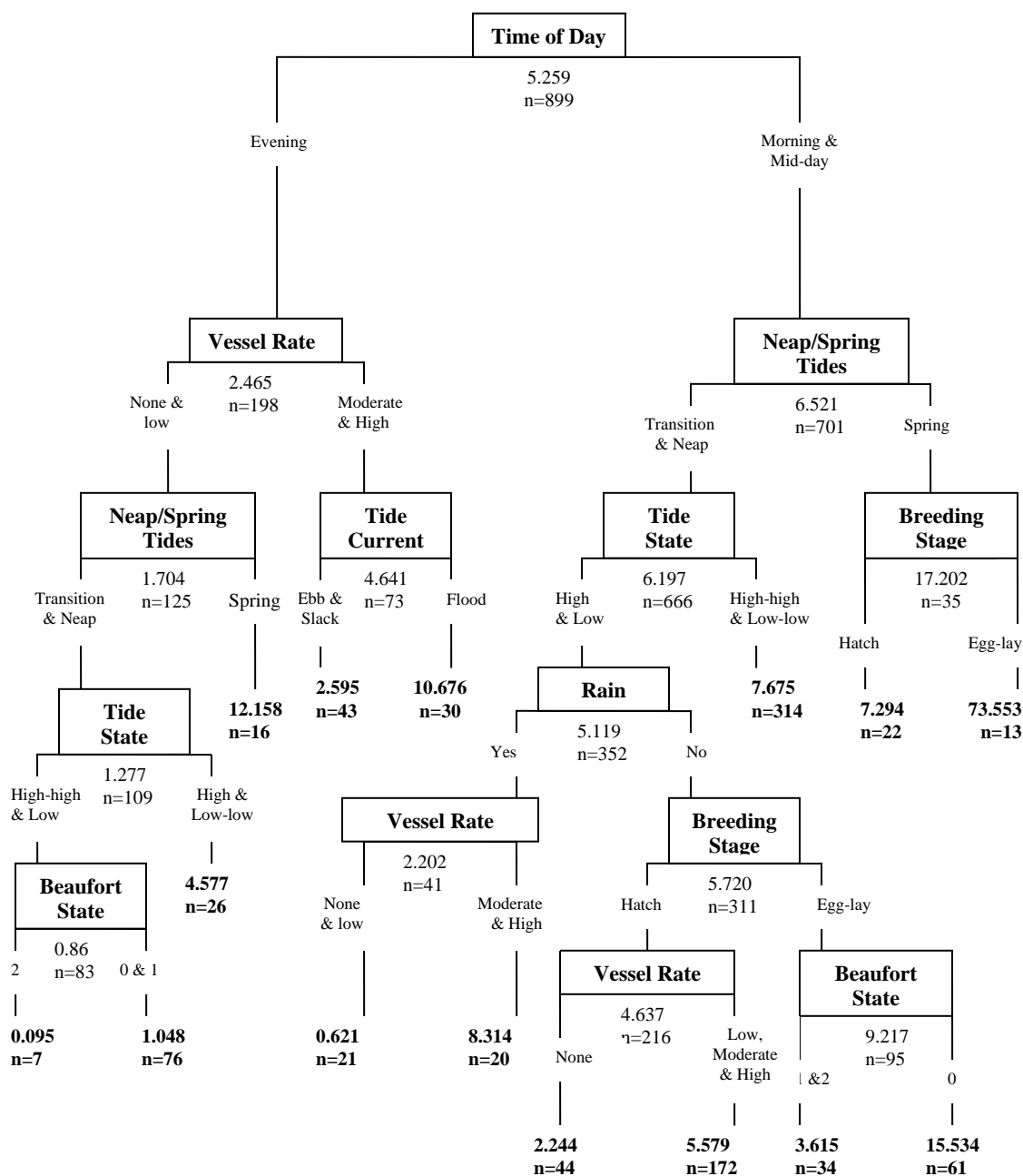

Figure 2.2. Best regression tree model of biological and environmental influences on Kittlitz's Murrelet near shore density at the daily time scale. For each branch the first numeric indicates mean density (Kittlitz's/km<sup>2</sup>).

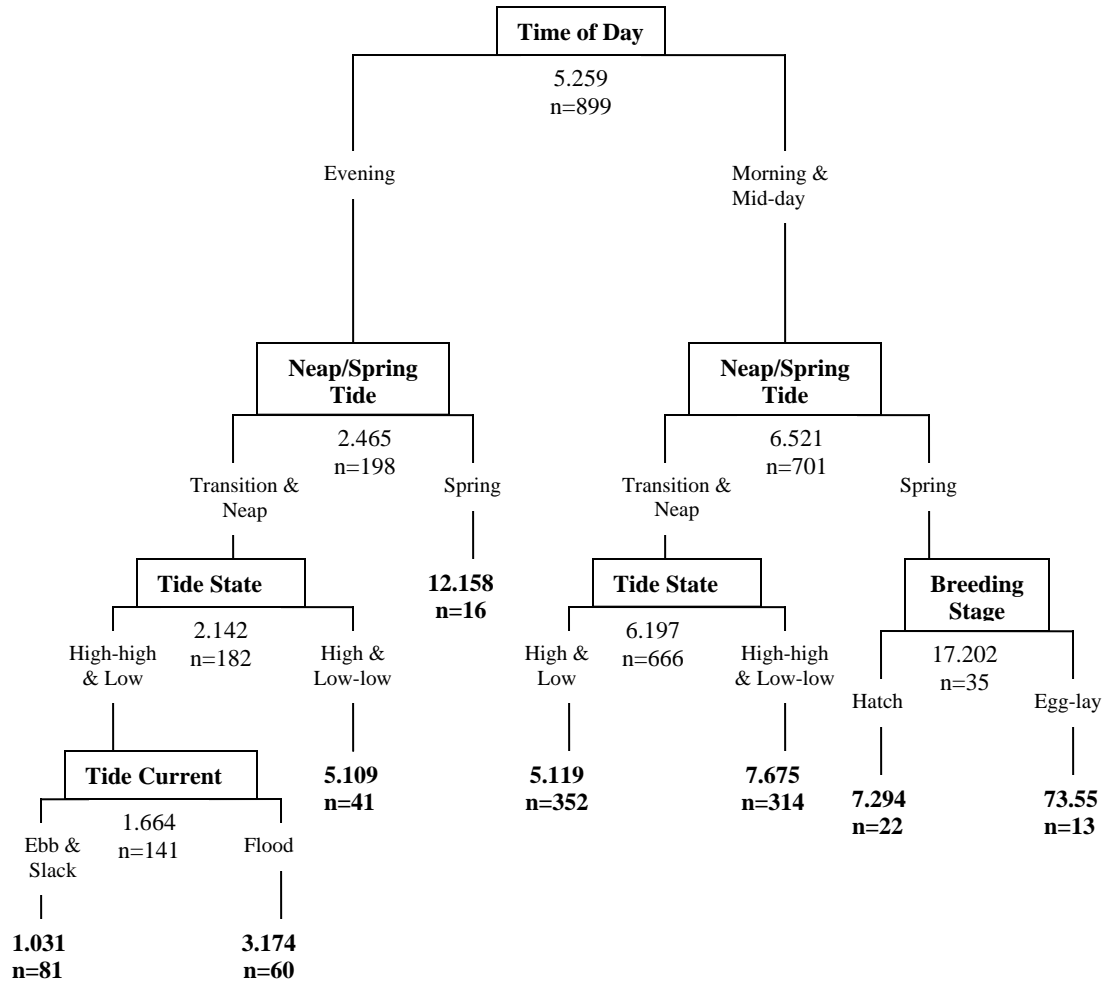

Figure 2.3. Best regression tree model of biological, environmental, and vessel factor (daily vessel rate) influences on Kittlitz's Murrelet near shore density at the daily time scale. For each branch the first numeric indicates mean density (Kittlitz's/km<sup>2</sup>).

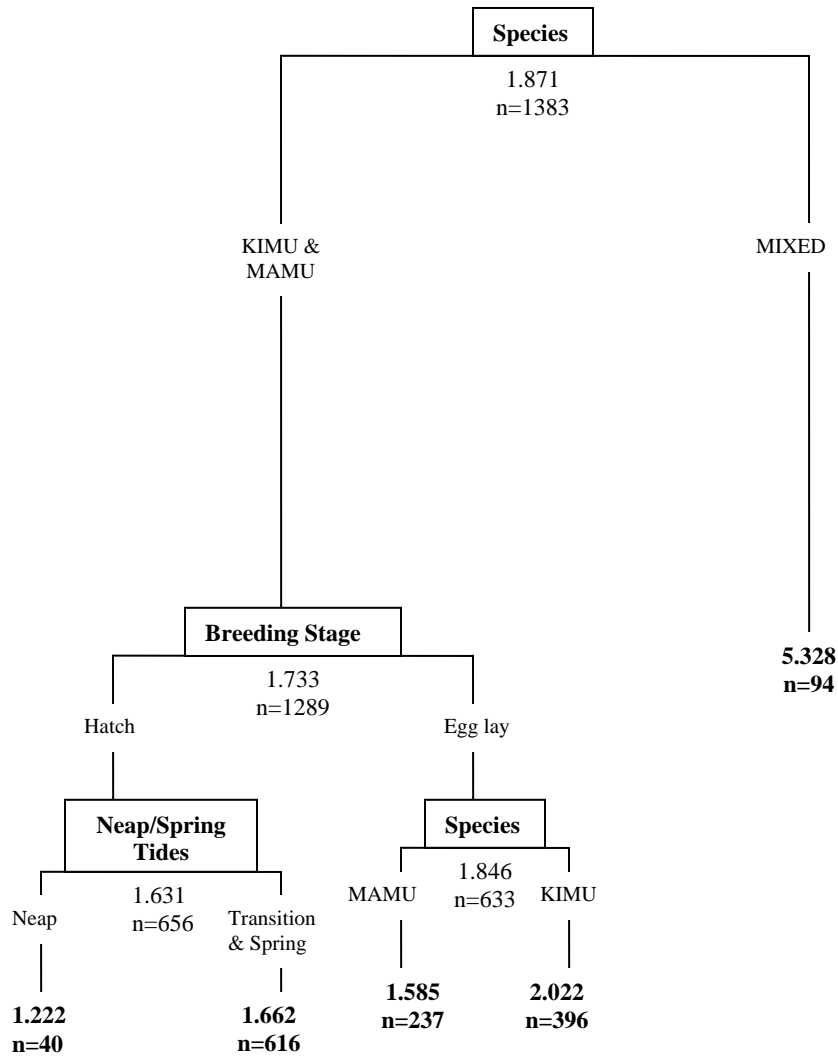

Figure 2.4. Best regression tree model of environmental, biological, and vessel factor (daily vessel rate) influences on Kittlitz's Murrelet group dynamics at the daily time scale. For each branch the first numeric indicates mean group size.

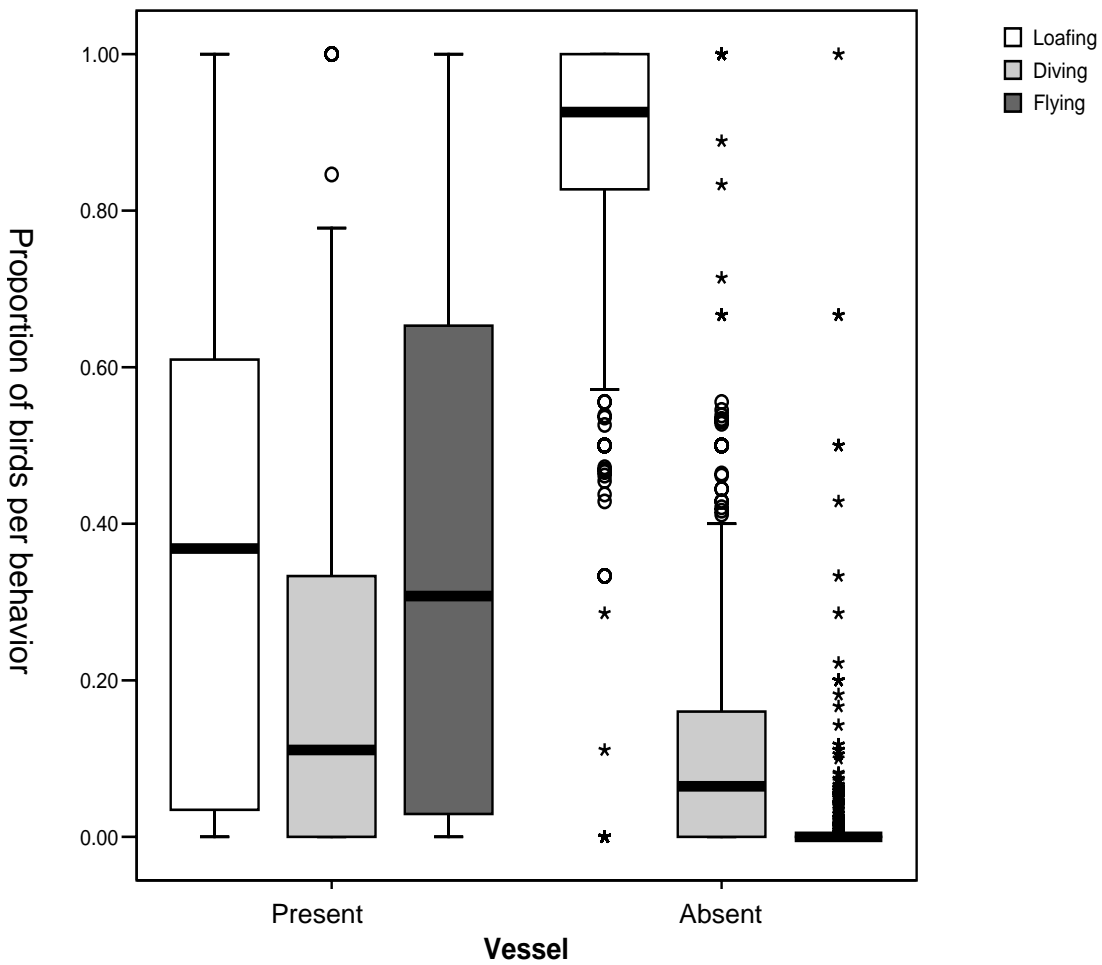

Figure 2.5. Median and quartile plots of Kittlitz's Murrelet behaviors (proportion of Kittlitz's per behavioral category: loafing, diving, flying) summarized in the presence and absence of vessel activity. Significant behavioral change was detected for loafing (decrease) and flying (increase) in the presence of vessels.

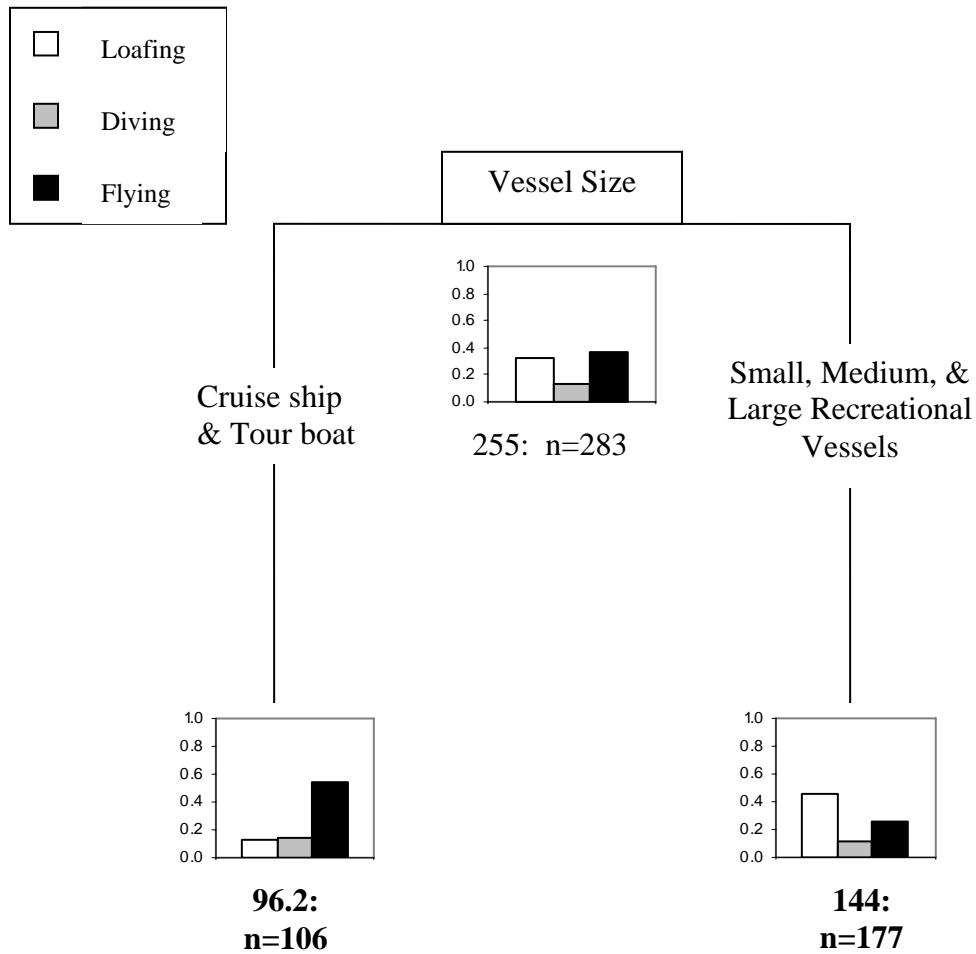

Figure 2.6. Best regression tree model of environmental, biological, and vessel factor (vessel size, speed, and approach distance) influences on variability in the immediate behavioral response of non-fish holding Kittlitz's Murrelets. For each leaf, the first numeric indicates the amount of unexplained deviance remaining. The y-axis of individual branch plots is the mean proportion of Kittlitz's engaged in each behavior category.



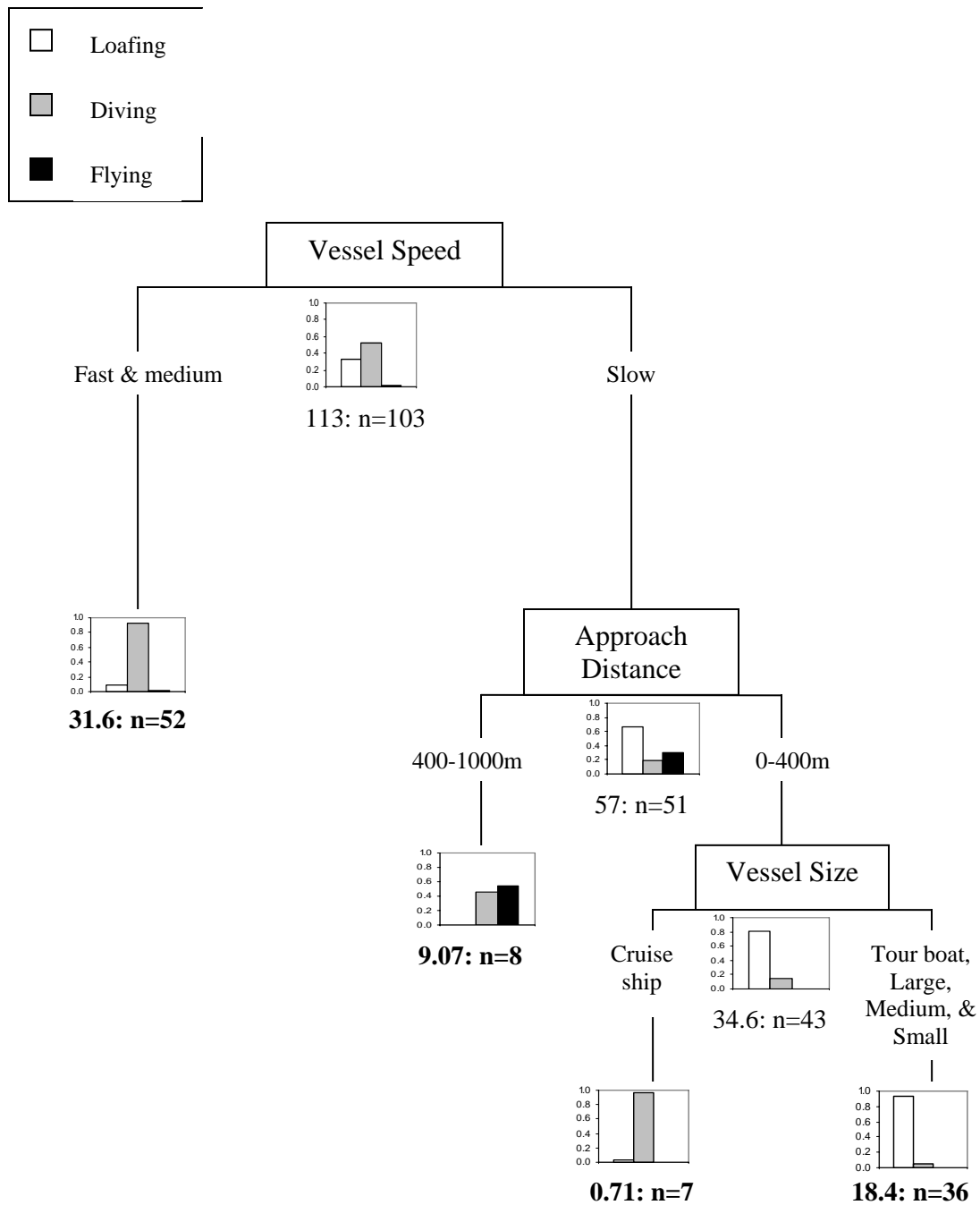

Figure 2.7. Best regression tree model of environmental, biological, and vessel factor (vessel size, speed, and approach distance) influences on variability in the immediate behavioral response of fish holding Kittlitz's Murrelets. For each leaf, the first numeric indicates the amount of unexplained deviance remaining. The y-axis of individual branch plots is the mean proportion of Kittlitz's engaged in each behavior category.

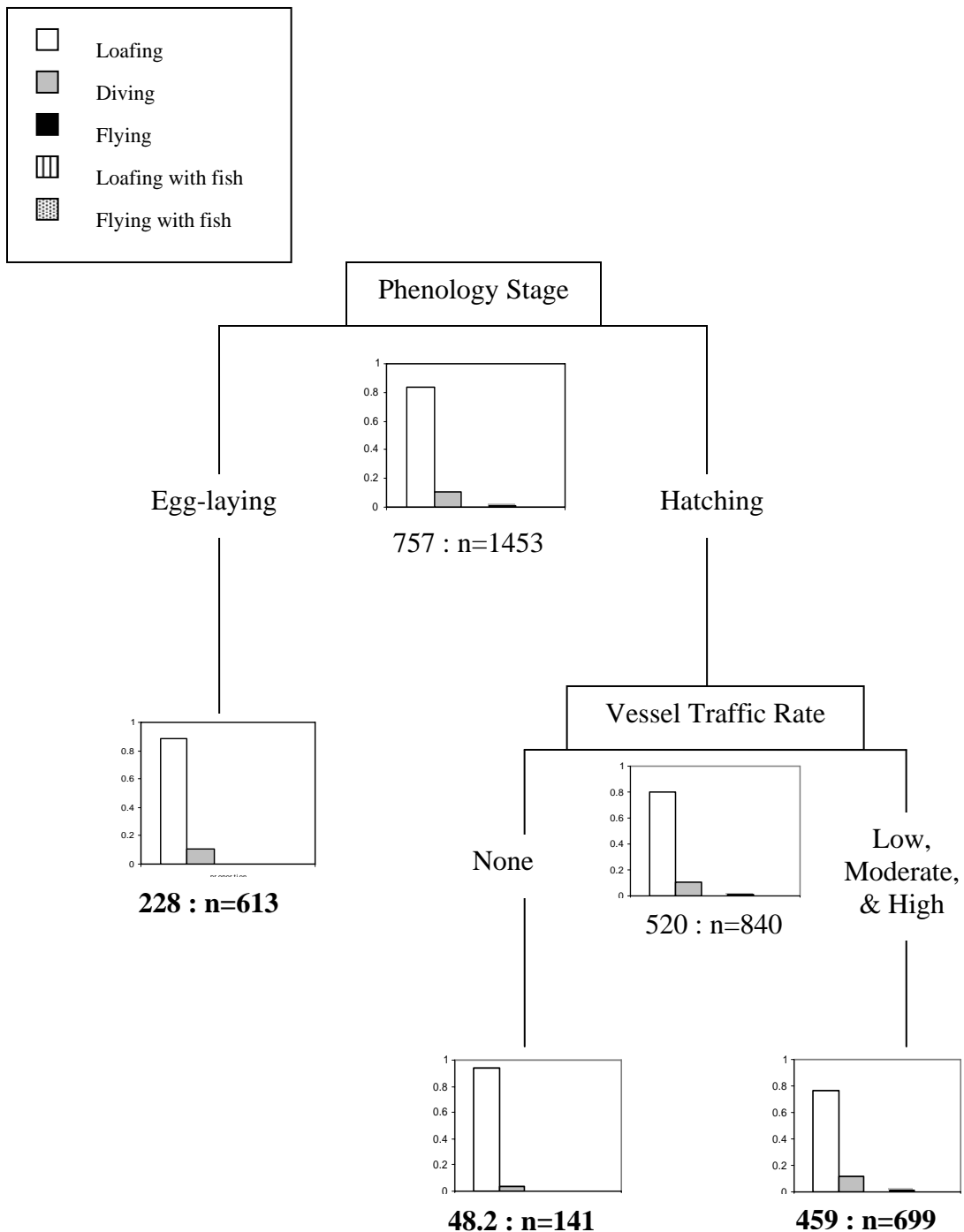

Figure 2.8. Best regression tree model of environmental, biological, and vessel factor (daily vessel rate) influences on Kittlitz's Murrelet behavior at the daily time scale. For each leaf, the first numeric indicates the amount of unexplained deviance remaining. The y-axis of individual branch plots is the mean proportion of time spent per behavioral category.

## Notes to Chapter 2

Altmann, J. 1974. Observational study of behavior: sampling methods. *Behaviour* 49(3-4): 227-267.

Bailey, A.M. 1927. Notes on the birds of southeastern Alaska. *Auk* 44:1– 23.

Bodkin, J.L., K.A. Kloecker, H.A. Coletti, G.G. Esslinger, D.H. Monson, B.E. Ballachey. 2001. Marine Predator Surveys in Glacier Bay National Park and Preserve. USGS-BRD annual report, 2001. Pp. 45.

Bramford, A. R., S. J. J. F. Davies, and R. van Delft. 1990. The effects of model power boats on waterbirds at Herdsman lake, Perth, Western Australia. *Emu* 90:260-265.

Breiman, L., J.H. Friedman, R.A. Olshen, and C.G. Stone. 1984. Classification and regression trees. Wadsworth International Group, Belmont, California, USA.

Carter, H. R. and S. G. Sealy. 1987. Fish-holding behavior of Marbled Murrelets. *Wilson Bulletin* 99:289-291.

Day, R. H., K. L. Oakley, and D. R. Darnard. 1983. Nest sites and eggs of Kittlitz's and Marbled Murrelets. *Condor* 85:265-273.

Day, R.H., K.J. Kuletz, and D.A. Nigro. 1999. Kittlitz's Murrelet (*Brachyramphus brevirostris*). In *The Birds of North America*, No. 435 (A. Poole and F. Gill, eds.). The Birds of North America, Inc., Philadelphia, PA.

Day, R.H., and D.A. Nigro. 2000. Feeding ecology of Kittlitz's and Marbled Murrelets in Prince William Sound, Alaska. *Waterbirds* 23(1): 1 – 14.

Day, R.H., A.K. Prichard, and D.A. Nigro. 2003. Ecological specialization and overlap of *Brachyramphus* murrelets in Prince William Sound, Alaska. *Auk* 120(3): 680 – 699.

De'ath, G., and K.E. Fabricius. 2000. Classification and regression trees: a powerful yet simple technique for ecological data analysis. *Ecology* 81(11): 3178-3192.

De'ath, G. 2002. Multivariate regression trees: A new technique for modeling species-environment relationships. *Ecology* 83(4): 1105-1117.

Hall, C.M. 2001. Trends in ocean and coastal tourism: the end of the last frontier? *Ocean and Coastal Management* 44:601-618.

Kaiser, M. S., E. K. Fritzell. 1984. Effects of river recreationists on Green-Backed Heron behavior. *Journal of Wildlife Management* 48(2): 561-567.

Korschgen, C. E., L. S. George, and W. L. Green. 1985. Disturbance of Diving Ducks by Boaters on a Migrational Staging Area. *Wildlife Society Bulletin* 13(3): 290-296.

Kuletz, K. 1989. Relative distribution of Marbled and Kittlitz's murrelets in Kachemak Bay, Alaska. *Pacific Seabird Group Bulletin*. 16: 60.

Kuletz, K., and J. Piatt. 1992. Distribution of Marbled and Kittlitz's murrelets in three bays in Alaska. *Pacific Seabird Group Bulletin* 19: 50.

Montevecchi, W.A., and J.F. Piatt. 1987. Dehydration of seabird prey during transport to the colony: Effects on wet weight energy densities. *Canadian Journal of Zoology* 65: 2822-2824.

Newton, I. 2004. The recent declines of farmland bird populations in Britain: an appraisal of causal factors and conservation actions. *Ibis* 146(4):579-600.

Norris, K., P.W. Atkinson, and J.A. Gill. 2004. Climate change and coastal waterbird populations – past declines and future impacts. *Ibis* 146:82-98. Suppl. 1

Pennycuik, C.J. 1989. *Bird flight performance: A practical calculation manual*. Oxford University Press, New York.

Piatt, J.F., N.L. Naslund, and T.I. van Pelt. 1994. Nest-site selection and fidelity in Kittlitz's Murrelet. *Beringian Seabird Bulletin* 2: 54 – 56.

Rodgers, J.A., and S.T. Schwikert. 2002. Buffer-zone distances to protect foraging and loafing waterbirds from disturbance by personal watercraft and outboard-powered boats. *Conservation Biology* 16(1): 216-224.

Schummer, M. L. and W. R. Eddleman. 2003. Effects of disturbance on activity and energy budgets of migrating waterbirds in south-central Oklahoma. *Journal of Wildlife Management* **67(4)**: 789-795.

Speckman, S.G., J.F. Piatt, and A.M. Springer. 2003. Deciphering the social structure of Marbled Murrelets from behavioral observations at sea. *Waterbirds* 26(3): 266-274.

Speckman, S. G., J. F. Piatt, and A. M. Springer. 2004. Small boats disturb fish-holding Marbled Murrelets. *Northwest Naturalist* 85:32-34.

Strachan, G., M. McAllister, and C. J. Ralph. 1995. Marbled Murrelet at-sea and foraging behavior. Pages 247–253 in *Ecology and conservation of the Marbled Murrelet* (C.J. Ralph, G.L. Hunt, Jr., M.G. Raphael and J.F. Piatt, Eds.). General Technical Report

PSW-152. U.S. Department of Agriculture, Forest Service, Pacific Southwest Research Station, Albany, CA.

van Vliet, G. 1993. Status concerns for the “global” population of Kittlitz’s Murrelet: is the “glacier murrelet” receding? *Pacific Seabird Group Bulletin* 20: 15 – 16.

van Vliet, G., and M. Mc Allister. 1994. Kittlitz’s Murrelet: the species most impacted by direct mortality from the Exxon Valdez oil spill? *Pacific Seabirds* 21: 5 – 6.

Wynee, K.M., D.L. Hicks, and N.R. Munro. 1992. 1991 Marine Mammal Observer Program for the salmon driftnet fishery of Prince William Sound, Alaska. Unpubl. report prepared for NOAA / NMFS, Alaska Region Office of Marine Mammals, Juneau, by Saltwater, Inc., Anchorage.

Zar, J.H. 1999. *Biostatistical analysis*. 4<sup>th</sup> edition. Prentice Hall, New Jersey, USA.

### **Chapter 3: Energetic impacts of vessel disturbance on the Kittlitz's Murrelet (*Brachyramphus brevirostris*): a simulation model approach**

#### **Summary**

Summer breeding populations of Kittlitz's Murrelet (*Brachyramphus brevirostris*) in Southeast Alaska have declined by 80-90% during the past 15 years. Documented sources of mortality (e.g., oil spills and gillnet bycatch) cannot fully explain the decline of populations, and other factors such as disturbance by vessels may contribute to the declines. Vessel activity overlaps in space and time with foraging areas of Kittlitz's Murrelet in Glacier Bay, Alaska. Vessels typically affect Kittlitz's on their foraging grounds by flushing them from the water, and this may disrupt foraging bouts, resting periods or chick provisioning trips. The goal of this study was to: 1) model energy expenditure associated with flight response of Kittlitz's Murrelet to vessel disturbance, and 2) test whether this behavioral response constitutes a significant biological impact on the birds' energy budget. I considered the flight energetics of murrelets that were actively engaged in chick-rearing, and of murrelets that were not actively provisioning chicks. Based on field observations in Glacier Bay, disturbance conditions were simulated using three scenarios. I varied the rate of vessel traffic and likelihood of vessel disturbance to predict the energy expenditure of flight under zero, maximum and average vessel conditions. The zero vessel scenario also incorporated parental costs of chick provisioning. I assumed the zero vessel scenario represented maximum flight energy to maintain fitness for the species, and compared average and maximum vessel scenarios to

the zero vessel scenario with t-tests to determine the level of energetic impact. Vessel disturbance posed a greater threat to Kittlitz's not actively provisioning chicks than to those engaged in chick-provisioning under the worst vessel conditions, because of a general lack of flight response in chick rearing murrelets. Under maximum vessel conditions, vessel disturbance posed a greater threat to murrelets that were not actively provisioning chicks than to those engaged in chick-provisioning. Under average vessel conditions, however, vessel disturbance posed little threat. Our findings help conceptualize the species risks related to vessel traffic. Future work should investigate whether additional energy costs, via endocrinology or physiology, exist for chick-rearing murrelets that were not accounted for through behavioral modeling.

## **Introduction**

Ecotourism may create disturbance and ecological change in wild terrestrial and coastal marine habitats. Motorized vessels are used for eco-tours in ecologically sensitive places (Hall 2001), leading to unprecedented levels of disturbance to aquatic species in areas which may have otherwise remained unperturbed. Known impacts of vessel disturbance on birds include increased mortality of offspring (Keller 1991, Mikola et al. 1994), behavior changes that have energetic consequences at high rates of vessel traffic (Korschgen et al. 1985; Schummer & Eddleman 2003), and a loss of suitable habitat (Kaiser & Fritzell 1984; Bramford et al 1990).

Studies of vessel disturbance suggest that the behavioral responses of birds are species-specific (Bramford et al. 1990; Bratton 1990; Pierce et al. 1993; Rodgers and Smith 1995, 1997; Rodgers & Schwikert 2002, 2003; Traut and Hostetler 2003). Thus, bird species must be studied on a case-by-case basis to understand the potential impacts of vessel disturbance. In this study, I examined the potential impact of vessel disturbance on the Kittlitz's Murrelet (*Brachyramphus brevirostris*).

Kittlitz's Murrelet is a candidate species for listing under the U.S. Endangered Species Act. Survey data from two core population areas in Alaska (Glacier Bay and Prince William Sound) indicate declines of 80-90% in the past 10-25 years (Robards et al. 2003, Kuletz et al. 2003, Piatt unpubl. data). Oil spills and gillnet mortality are well documented causes of Kittlitz's Murrelet mortality in some areas of Alaska (Wynne et al. 1992, van Vliet 1993, van Vliet and McAllister 1994, Day et al. 1999). Because these anthropogenic sources of mortality are either absent (gillnet fishing, Dept. of Interior 1991), or not large enough (oil spills, Eley 2000) to account for recent population declines in Glacier Bay, undocumented factors likely contribute to the overall decline. Other possible causes of decline include changes in climate that affect food supply and habitat, winter mortality, and vessel disturbance in core foraging areas (Day et al. 1999).

During summer, Glacier Bay National Park (GBNP) is a major tourist destination (323,500 visitors in 2004, GBNP Scientific Advisory Board 2004) in Southeast Alaska. Most tourists view Glacier Bay from vessels, including cruise ships, commercial tour



boats, and private recreational vessels. Tidewater glaciers in Glacier Bay are a draw for tourists and consequently vessel activity is high in their vicinity. Glacial waters near tidewater glaciers and the outflow of glacial streams are also preferred foraging habitat for the Kittlitz's Murrelet (Day et al. 1999, Day and Nigro 2000, Day et al. 2003). Thus, vessel activity, therefore, overlaps in space and time with murrelets and this may interfere with their foraging activity.

Does occasional disturbance on the feeding grounds present a problem for Kittlitz's Murrelets? The goal of this study was to model energy costs associated with the flight response of Kittlitz's Murrelet to vessel disturbance and assess whether this behavioral change constitutes energetic impact. I contrasted the flight energetics of Kittlitz's actively engaged in chick-rearing with birds that were not actively provisioning chicks. Chick rearing has a high energetic cost for the Kittlitz's Murrelet because nest sites are located up to 75 km inland (Day et al. 1983) and their mode of flight is energetically costly (Pennycuik 1987). Murrelets hold a single fish cross-wise in the bill for later delivery to chicks (Carter & Sealy 1987, Strachan et al. 1995). Thus, fish holding behavior indicates that subject murrelets (hereafter called fish holders) are rearing chicks (Speckman et al. 2003, Tranquilla et al. 2005).

I based our model on observations of murrelet behavior at sea (Chapter 2). To determine the effect of vessel disturbance on Kittlitz's Murrelet, Agness (Chapter 2) observed Kittlitz's that inhabited near-shore areas of Glacier Bay (Figure 3.1) in the presence and

absence of vessels. During vessel activity, an observer recorded all loafing Kittlitz's within 1000m of the vessel, their initial behavioral response, the vessel approach distance (0-400m or 400-1000m), size (small: 0-6 m; medium: 6-18 m; large: 18-27 m; tour boats: 30-49 m; cruise ships: 305+ m) and speed (slow: 0-16 km/h; moderate: 17-32 km/h; fast: 33-48 km/h). Loafing describes the behavior of being at rest on the water's surface. For each vessel event, the number of Kittlitz's engaged in behavior categories (dive, fly, or no response) by approach distance category were recorded and summarized for model input. I additionally monitored the rate of vessel traffic at each of seven observation sites (Figure 3.1), and the observed distributions of these data were used to simulate vessel traffic conditions (Chapter 2).

Vessels disturb Kittlitz's on their foraging grounds by causing them to fly (Chapter 2). Flight is energetically costly. It may disrupt resting, foraging, and occasionally chick provisioning trips. They usually spend little time ( $\bar{x} = 67 \pm 1$ s.e. 4 sec) flying after any one vessel disturbance (Agness unpubl. data). The rate of vessel traffic (vessels/hr) in near-shore areas of Glacier Bay, however, varies markedly (range: 0 – 1.5 vessels/hr), and the potential impact of disturbance is greater with higher rates of vessel traffic (Chapter 2). The likelihood of Kittlitz's flight response is related to vessel speed, size, approach distance (distance between a bird and vessel), and whether or not the bird is holding a fish in its bill (Chapter 2). In order to simulate disturbance conditions in Glacier Bay, I considered three scenarios and varied the rate of vessel traffic and

likelihood of vessel factors in order to predict the energy expenditure of flight under best, worst and average vessel conditions.

## **Methods**

### *2.1 Model structure & parameters*

To simulate daily flight energy budgets I parameterized two models, one for fish holders and one for non-fish holders. Each model simulated one thousand days for which a vessel traffic rate was selected from an observed distribution and each vessel was iterated to determine whether it caused a flight risk to birds. A series of binomial tests were used to determine vessel characteristics and then bird flight response to each vessel. Our model parameters came from field study (Chapter 2), published literature sources and unpublished data on the Kittlitz's Murrelet. Parameters used to derive the energy budgets included three sources of energy costs: flight response from vessels, flight to and from nests and maintenance costs. Kittlitz's Murrelet spend most time swimming on or below the sea surface (Chapter 2). Therefore, I assume that all flight was caused by vessel response or flying to and from the nest site. Because flight response varied with vessel factors such as speed, size and approach distance, I included these factors explicitly in the model to predict the probability of flight. Our models provided the daily energy of an average Kittlitz's Murrelet, because each simulation represented a new day and I assumed that each day a single bird could be encountered by every vessel passing through

the area. Model structure incorporated parameters with both observed distributions and static estimates (Figures 3.2 and 3.3).

### *2.1.1 Flight energy*

I used the aerodynamic flight performance model of Pennycuick (1989) and his flight software (version 1.15) to calculate the chemical power (W) of Kittlitz's Murrelet flight under three conditions. I calculated the power of their flight holding a fish at low altitude (5m), holding a fish at high altitude (500m) and without a fish at low altitude. I assumed 5 m altitude for relatively short flights of both fish holding and non-fish holding Kittlitz's in response to vessel disturbance and 500 m altitude flight for the nest commutes of fish holders. In order to create species specific power curves, I used morphological data for the Kittlitz's Murrelet including average mass ( $233.6 \pm 1$  S.E. 4.3 g, J. Piatt unpubl. data), and estimates of wing span (0.47 m) and wing area ( $0.0081 \text{ m}^2$ ) estimated from measurements derived from Marbled Murrelets (Elliot et al. 2004). I assumed that fish holders had a mass 10 g greater than the average Kittlitz's Murrelet mass to account for the additional weight of the fish they carried (Montevecchi and Piatt 1987).

Our estimates of wing span and wing area for the Kittlitz's Murrelet were informed by calculating a ratio of Kittlitz's Murrelet wing chord to Marbled Murrelet wing chord ( $142.8/132.5 = 1.0777$ ) (Piatt unpubl. data). I multiplied reported (Elliot et al. 2004) measures of Marbled Murrelet wing span ( $0.44 \pm 0.01$  m) and wing area ( $0.0075 \pm 0.0006 \text{ m}^2$ ) by this ratio to estimate wing span and wing area for the Kittlitz's Murrelet. I

compared the mass ratio of the Kittlitz's and Marbled Murrelet to the wing chord ratio (mass ratio:  $233.6/219.0 = 1.0667$  vs. wing chord ratio:  $1.0777$ ). The two ratios were almost identical, validating our approach to morphological estimation.

Kittlitz's Murrelet use muscle-powered flapping flight, which has high energetic cost (in contrast to soaring flight, for example). Because this flight strategy is costly, I assumed that Kittlitz's always flew at maximum range speed (Pennycuick 1989). I used the chemical power that corresponded with maximum range speed on the three power curves (fish holder at low altitude:  $50.04$  kJ/hr; fish holder at high altitude:  $51.48$  kJ/hr; and non-fish holder at low altitude:  $47.16$  kJ/hr).

### *2.1.2 Vessel flight energy*

I used an observed distribution of flight times from individual Kittlitz's in our simulations, with a mean flight time of  $67 \pm 4$  S.E. sec (Agness unpubl. data). When flight from a vessel occurred in simulations, the model sampled the distribution of flight times and multiplied flight time by the respective energy value ( $50.04$  kJ/hr for fish holders and  $47.16$  kJ/hr for non-fish holders) to estimate kJ consumed. This process was repeated for all vessel disturbances simulated within a day.

### *2.1.3 Nest commute flight energy*

Flight during nest commute was only applicable to simulations involving fish holding Kittlitz's, as this behavior is associated with chick provisioning. I used published data on

Kittlitz's Murrelet flight speed (94 km/hr) and the distance inland from shore of 14 nest locations (range: 0.3 – 75 km;  $\bar{x}$  :18.28  $\pm$  4.89 SE km) (Day et al. 1983, Day 1995, Day et al. 1999) to calculate an estimate for the minimum time spent in flight during trips to nests (range: 0.003 – 0.80 hr). When a fish holder was simulated, the model sampled the distribution of nest commute times, and multiplied a selected flight time by the energy value (51.48 kJ/hr) to estimate kJ consumed. A study of an active Kittlitz's nest found that between four and six trips to and from the nest are taken per day by a pair of provisioning Kittlitz's Murrelet, and both adults share this task equally (Naslund et al. 1994, Day et al. 1999). For each fish holder modeled, three round trips were simulated. Flight time remained the same for repeated trips to the nest by a simulated fish holder. Energy consumed for all trips in a day were summed to calculate total energy consumed during nest commutes.

#### *2.1.4 Maintenance energy*

I used an allometric equation specific to seabirds to calculate the daily basal metabolic energy of Kittlitz's Murrelet (Bryant and Furness 1995).

$$\text{BMR}=2.3(W)^{0.774}, \text{ where } W \text{ is average mass and BMR is basal metabolic rate.}$$

I used the same average mass (233.6 g) data used to derive flight power curves. I used a suggested multiple for seabirds of three times basal metabolic rate for the field metabolic rate (Bryant and Furness 1995), which I called maintenance energy (469.9 kJ/day). Thus,

for all times of day birds were not flying, we assumed they were burning energy at the rate needed for maintenance. This underestimates total costs because we were not including dive costs.

### *2.1.5 Probability of flight from vessels*

Based on field study, I knew that fish holders were most likely to fly in response to slow, distant (400-1000m) vessels, and non-fish holders in response to large vessels (cruise ships and commercial tour boats) (Chapter 2). To determine in the model whether a bird flew from a given set of vessel disturbance characteristics I used a binomial test with the probability of flight as the overall proportion of observed birds that flew from that set of vessel disturbance characteristics (Table 3.1). For each bird that flew, I followed the model process to calculate flight energy costs.

## *2.2 Model scenarios*

I developed three scenarios of vessel traffic to evaluate the energy budget of the Kittlitz's Murrelet under zero, average and maximum vessel conditions. To simulate the zero vessel scenario, I considered the energy budget without vessel disturbance. For this scenario, I also assumed the fish holder energy budget, which varied as a result of the distribution of nest commute duration, but only included nest commute and maintenance energetic costs.

For the maximum vessel scenario, I assumed that all vessels permitted to enter Glacier Bay on a given day caused vessel disturbance to the simulated average Kittlitz's Murrelet. During 2004, two cruise ships and nine large tour boats were permitted to enter the waters of Glacier Bay National Park each day through the summer season (late May – late September). Up to 25 private recreational motor-vessels were also permitted to tour the park per day from 1 June through 31 August. I assumed that each vessel could potentially disturb a Kittlitz's Murrelet twice by traveling into and out of a specific area. To account for this, I multiplied the maximum number of vessels in park waters (36 vessels) by two to get the number of vessel disturbances under worst case conditions (72 disturbances). I used our knowledge of vessel factors that cause the greatest flight response to create the most probable conditions for flight response in model simulations (Chapter 2). I retained the same decision rules that were used for average conditions, but increased the rate of vessel traffic without changing the probabilities of vessel characteristics. I used the maximum number of cruise ship and tour boat sized vessels and let all other vessel characteristics occur with the same frequencies as observed to simulate the most energetically costly scenario for non-fish holders.

I used field data to inform simulations of average vessel disturbances for the average vessel scenario (Chapter 2). I incorporated the observed distribution of vessel traffic rate per day (n=42 days), and our model sampled from this distribution to assign a representative vessel rate for the day. I then modeled the probability of a vessel being a certain size, speed, or approach distance based on observed distribution of vessel factors.



### 2.3 Data analysis

Each model scenario was simulated 1000 times in Matlab (version 7), and I compared the output of different scenarios with t-tests. I assumed that under natural conditions the species approaches or begins to exceed maximum energy flux to maintain fitness during the chick-rearing stage of the breeding season (Golet et al. 2004, Daan et al. 1996, Drent and Daan 1980), in part because of the high energetic cost of flying back and forth to the nest. Flight response from vessel disturbance was considered an unnatural perturbation. Thus, our zero vessel scenario for fish holders represents a situation with maximum energy consumption, and we refer to this as simply, the zero vessel scenario. All comparative tests using the zero vessel scenario represent this scenario for fish holders, and approximate maximum energy flux for the species.

I compared zero and average vessel scenarios for fish holders with a t-test to determine the impact of vessel disturbance on Kittlitz's Murrelet during chick-rearing. If the average vessel scenario for fish holders represented greater energy consumption than the zero vessel scenario ( $\alpha= 0.05$ ), then it seems likely that vessel disturbance caused energetic impact to the species during chick-rearing. Likewise, if the average vessel scenario of non-fish holders represented greater energy consumption than the zero vessel scenario ( $\alpha= 0.05$ ), I concluded that vessel disturbance caused energetic impact to the species outside of the chick-rearing stage. I also tested the average case scenario for both fish holders and non-fish holders against their respective maximum vessel scenarios. The

decision rule was that vessel disturbance could cause greater energetic impact for the current vessel quota in Glacier Bay than was estimated by average vessel conditions if the energetic cost of the maximum vessel scenario was greater ( $\alpha= 0.05$ ) than the average vessel scenario.

Our simulation distributions were skewed or non-normal in some instances, and I used two tailed t-tests in ensure that our results were not biased by uneven distribution between tails. I reported the direction of the mean difference for each test to indicate whether our directional hypotheses should be rejected or accepted. I used Levene's test of equal variance, and when the assumption of equal variance was violated, I adjusted degrees of freedom with Welch's modified t-test (SPSS).

## Results

The simulated energy budget of fish holders under the average vessel scenario ( $\bar{x}$  energy budget:  $532.4 \pm \text{SE } 2.1$  kJ/day) was not significantly different from their energy budget under the zero vessel scenario ( $\bar{x}$  energy budget:  $529.9 \pm \text{SE } 2.0$  kJ/day) (Levene's test for equal variance:  $F=0.001$ ,  $p= 0.970$ ; 2-tailed t-test:  $t= 0.882$ ,  $df= 1998$ ,  $p= 0.378$ ) (Figures 3.4, 3.5 and 3.6). The difference between non-fish holder energy use under the average vessel scenario ( $\bar{x}$  energy budget:  $489.6 \pm \text{SE } 0.6$  kJ/day) and the zero vessel scenario, however, was significant. Non-fish holders exerted 40.4 kJ less energy under average vessel conditions than under the zero vessel scenario (Levene's test for equal

variance:  $F= 807.403$ ,  $p< 0.0001$ ; 2-tailed t-test:  $t= -18.820$ ,  $df= 1175.865$ , 2-tailed  $p < 0.0001$ ) (Figures 3.4, 3.6 and 3.7).

Fish holders under maximum vessel conditions ( $\bar{x}$  energy budget:  $567.3 \pm SE 2.1$  kJ/day) exerted 34.9 kJ more energy than under average vessel conditions (Levene's test for equal variance:  $F=0.038$ ,  $p= 0.844$ ; 2-tailed t-test:  $t= 11.798$ ,  $df= 1998$ ,  $p< 0.0001$ ) (Figures 3.4, 3.5 and 3.8). This additional energy was less than the energy gained from a Kittlitz's Murrelet consuming approximately one 10 g Pacific Sandlance (Anthony et al. 2000: energy density  $\sim 5.2$  kJ/g wet mass), assuming assimilation of 76% (one Pacific Sandlance = 39.5 kJ) which has been used in other studies of Marbled Murrelet and Cassin's Auklet (Hull et al. 2001, Monetvecchi et al 1984, Hodum et al. 1998). Non-fish holders under maximum vessel conditions ( $\bar{x}$  energy budget:  $750.2 \pm SE 1.6$  kJ/day) exerted 260.5 kJ more energy than under average vessel conditions (Levene's test for equal variance:  $F=572.830$ ,  $p< 0.0001$ ; 2-tailed t-test:  $t= 154.303$ ,  $df= 1294.479$ ,  $p< 0.0001$ ) (Figures 3.4, 3.7 and 3.9). The energetic cost of maximum vessel conditions for non-fish holders (260.5 kJ/day) was the equivalent of a Kittlitz's Murrelet consuming an additional 6.4 Pacific Sandlance per day at 76% assimilation.

I explored the model distributions further by performing the comparative tests (average vessel scenario vs. zero vessel scenario, and maximum vessel scenario vs. average vessel scenario) for a number of distribution percentiles (5, 10, 25, 50, 75, 90, and 95) (Table 3.2). I did not find any energy costs (kJ) of average vessel conditions, as shown by the

0.0 or negative energetic differences between average and zero vessel scenario comparisons across the range of percentiles (5 through 95) for fish holders and non-fish holders. Percentile comparisons of maximum vessel conditions found energetic costs between 23.5 and 47.9 kJ/day for fish holders, equivalent to additional consumption between < 1 and 1.4 Pacific Sandlance (Table 3.2). For non-fish holders energetic costs across percentile comparisons were between 202.4 and 321.8 kJ/day for non-fish holders, or equivalent to the additional consumption of between 5.8 and 9 Pacific Sandlance (Table 3.2). Percentile comparisons represented a range of energetic values around the mean energy differences evaluated with t-tests, and therefore provide greater understanding of the risks associated with vessel disturbance for a range of probabilities within the distributions.

## **Discussion**

Our simulations indicated that average vessel disturbance conditions did not increase energetic costs of fish holders or non-fish holders. The energetic cost for fish holders under average vessel conditions was not significantly different from that of the zero case scenario, which indicated that energy costs associated with vessel traffic were not large enough to burden individual fish holders beyond the stress of chick-rearing. The cost for non-fish holders, however, was 40.4 kJ/day less than the zero vessel scenario, indicating that the level of energetic cost associated with vessel traffic was within the biological

capability of the species. Recall that the estimated field metabolic rate for Kittlitz's was 469.9 kJ/day, or the energetic equivalent of consuming 12.4 Pacific Sandlance.

When I compared both fish holder and non-fish holder energy budgets under average vessel conditions to the maximum case conditions, the t-test results indicated respectively higher levels of energetic cost under the maximum vessel scenarios than were found in our previous comparative tests. Thus, greater vessel disturbance levels and consequently higher energetic cost to Kittlitz's were more feasible under the current vessel quota in Glacier Bay National Park than the average day implies.

Simulated fish holders experienced an average increase in energetic cost equivalent to consuming slightly less than one additional Pacific Sandlance per day, a level of energetic cost that most likely does not impact the species. Percentile comparisons across the distributions compared also found low energy costs for fish holders equivalent to the consumption of between  $<1$  and 1.4 Pacific Sandlance, which makes our conclusion more robust. Kittlitz's Murrelets spend considerable time loafing on the water in daily time budgets, and therefore do not maximize time spent diving (Chapter 2). It is probable that the time budgets of Kittlitz's Murrelet are flexible enough to accommodate the additional diving activity that would result in one successful prey encounter. The additional energetic cost of less than one Pacific Sandlance (8% of FMR) seems unlikely to impact the fitness of individual fish holders. Simulated non-fish holders conversely experienced greater energetic cost during maximum vessel conditions, equivalent to the consumption

of 6.5 Pacific Sandlance. The difference reflects the generally greater tendency of non-fish holders to take flight in response to vessel disturbance (see Table 3.1). This high level of energy cost would likely cause stress to individuals, as 260.5 kJ/day was 55% of their estimated field metabolic rate (469.9 kJ/day). High energetic costs for non-fish holders were also found with percentile comparisons across the distributions, equivalent to the consumption of between 5.8 and 9 additional Pacific Sandlance, or up to 67% of field metabolic rate, which lends further validation to these conclusions.

At high levels of energetic cost, non-fish holders can potentially be stressed to the level of allostatic overload (McEwen and Wingfield, 2003) from vessel disturbance in a worst case scenario of the possible vessel conditions. Allostatic overload is the point beyond which stress will affect the fitness of an animal (Wikelski and Cook, 2006). An allostatic stress threshold can be determined with some difficulty under experimental protocols (i.e. Sanz et al. 2000). Although there is an upper limit to the energy expenditure rate of the Kittlitz's Murrelet, I do not know the level of energy expenditure associated with the allostatic limit. Our findings about the energetic costs of vessel disturbance to the Kittlitz's Murrelet put perspective on the behavioral changes the species experiences in the presence of vessels, but I cannot delineate the specific fitness impacts Kittlitz's Murrelets may face as a consequence of vessel disturbance.

I have demonstrated that flight behavior induced by vessel disturbance poses a greater threat to non-fish holders than to fish-holders under worst-case vessel conditions, but

poses little to no threat for fish holders or non-fish holders under average vessel conditions. Average vessel conditions resulted in lower energy costs to both fish holders and non-fish holders than the possible worst case scenario. Our findings will help resource managers conceptualize the energetic consequences of behavioral change that accompanies vessel disturbance for Kittlitz's Murrelets, which may be useful to future evaluation of limits or increases in the regulation of vessel quotas. Future work should investigate whether additional energy costs, via endocrinology or physiology, exist for chick-rearing murrelets that were not accounted for through behavioral modeling. For example, although chick rearing Kittlitz's Murrelets had a low probability of flight response to vessel disturbance, it is possible that stress hormones or heart rate were elevated. Chick rearing murrelets may not respond to vessel disturbance with flight because parental duties are considerably taxing, meaning they simply do not have the energy to fly away. Our results confirmed that greater vessel traffic rates caused higher energy costs to the species and greater risk of impact. Further research should attempt to characterize the level of energy expenditure that causes allostatic overload for the Kittlitz's Murrelet, or closely related species. Endocrinological techniques (i.e. Walker et al. 2005) could be used in an experimental framework to identify the allostatic threshold for the species.

Table 3.1. Model parameters used for each vessel iteration in a simulation for the probability of occurrence of disturbance characteristics and consequent probability of Kittlitz's Murrelet flight. Probabilities were derived from field study by Agness (Chapter 2).

Bird type	Disturbance Characteristic	Probability of Disturbance Characteristic	Probability of Flight
Fish holder	Fast / Medium Vessel Speed	0.648	0.020
	Slow Vessel Speed	0.352	0.132
	Far Approach	0.232	0.132
	Close Approach	0.768	0.000
Non-Fish holder	Cruise ship / Tour boat	0.219	0.656
	Small / Medium / Large Recreational Vessel	0.781	0.358



Table 3.2. Exploratory analysis of distribution tails and associated percentile tests of the two comparative tests: average vessel scenario vs. zero vessel scenario and maximum vessel scenario vs. average vessel scenario. The energy difference is shown at each distribution percentile (kJ) per comparative test, along with the respective number of fish that a murrelet would have to consume to overcome the associated energetic costs.

Fish holders				
Distribution Percentiles	Comparative Test: Ave. vs. Zero (kJ)	Fish consumed	Comparative Test: Max. vs. Ave. (kJ)	Fish consumed
5	0.0	0	24.4	<1
10	0.0	0	23.8	<1
25	0.0	0	32.0	<1
50	0.0	0	47.9	1.4
75	0.0	0	30.9	<1
90	0.0	0	48.9	1.4
95	0.0	0	23.5	<1
Non-Fish holders				
5	-0.9	0	202.4	5.8
10	-9.9	0	218.1	6.3
25	-14.5	0	241.2	6.9
50	-10.6	0	264.0	7.6
75	-69.8	0	283.2	8.1
90	-83.0	0	303.0	8.7
95	-191.8	0	312.8	9

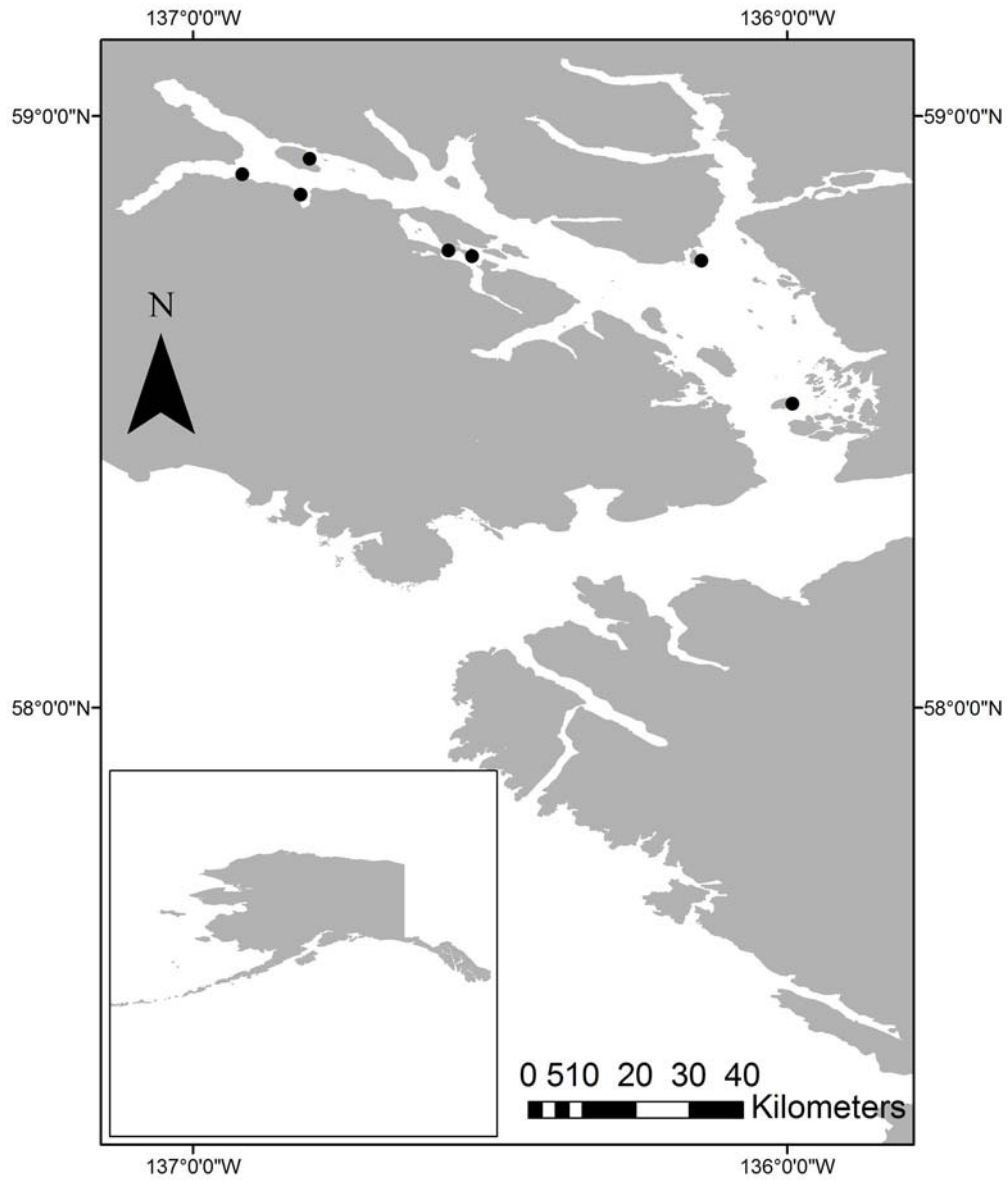

Figure 3.1. Location of field sites used by Agness (Chapter 2) in Glacier Bay, Alaska, denoted with black circles. The four sites furthest to the northwest were glacial, and the three remaining sites to the southeast were non-glacial.

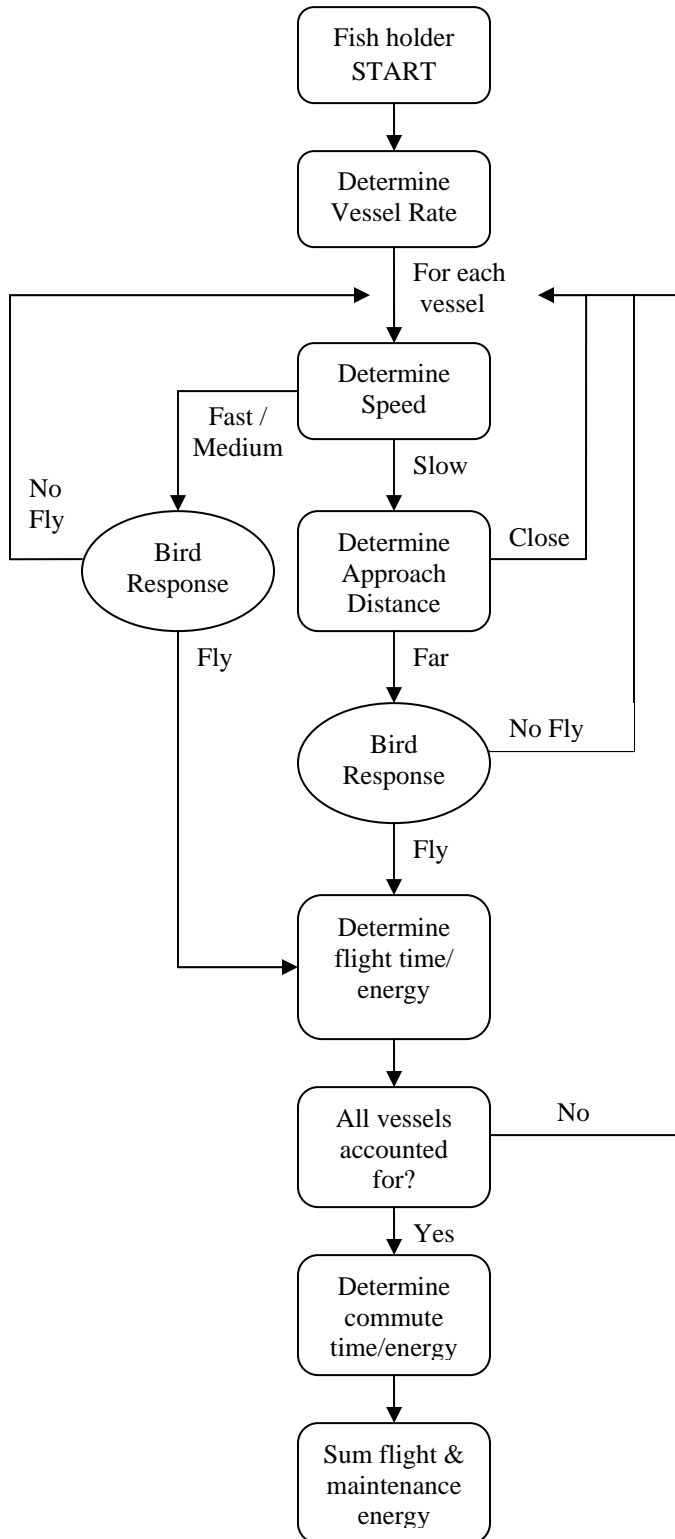

Figure 3.2. A schematic diagram of the conceptual framework and structure for fish holder model simulations.

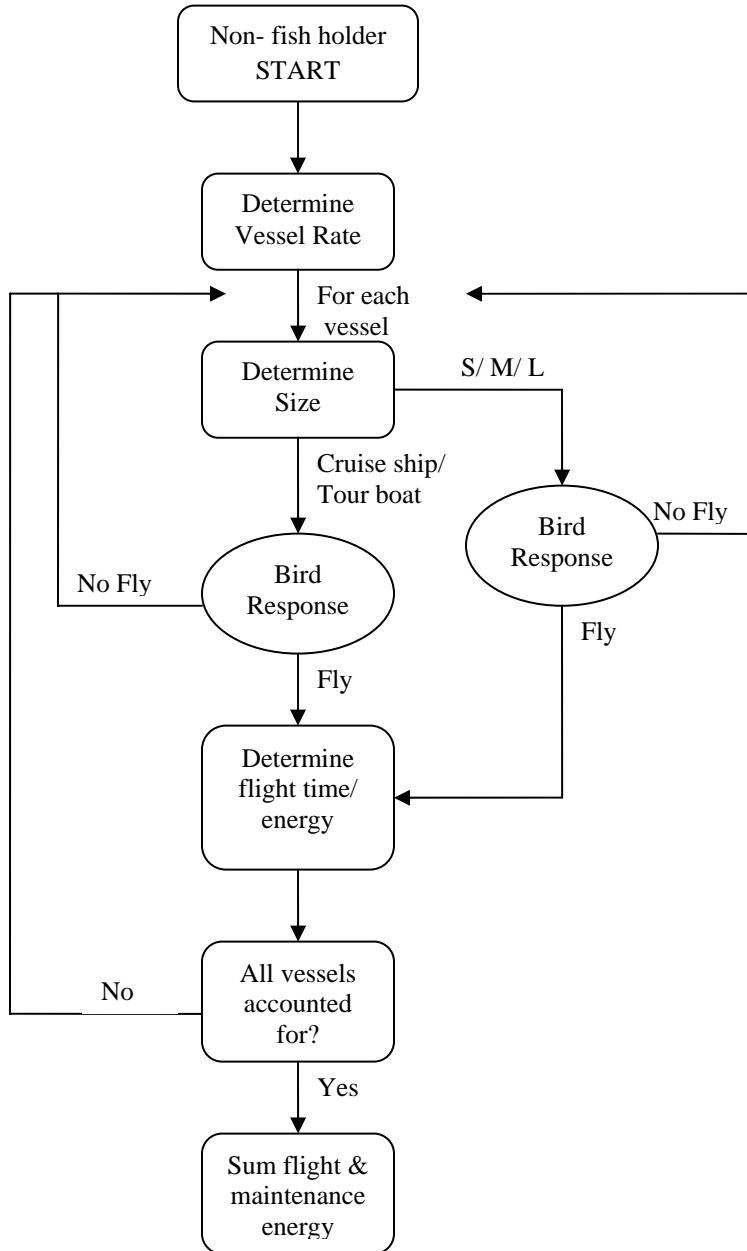

Figure 3.3. A schematic diagram of the conceptual framework and structure for non-fish holder model simulations.

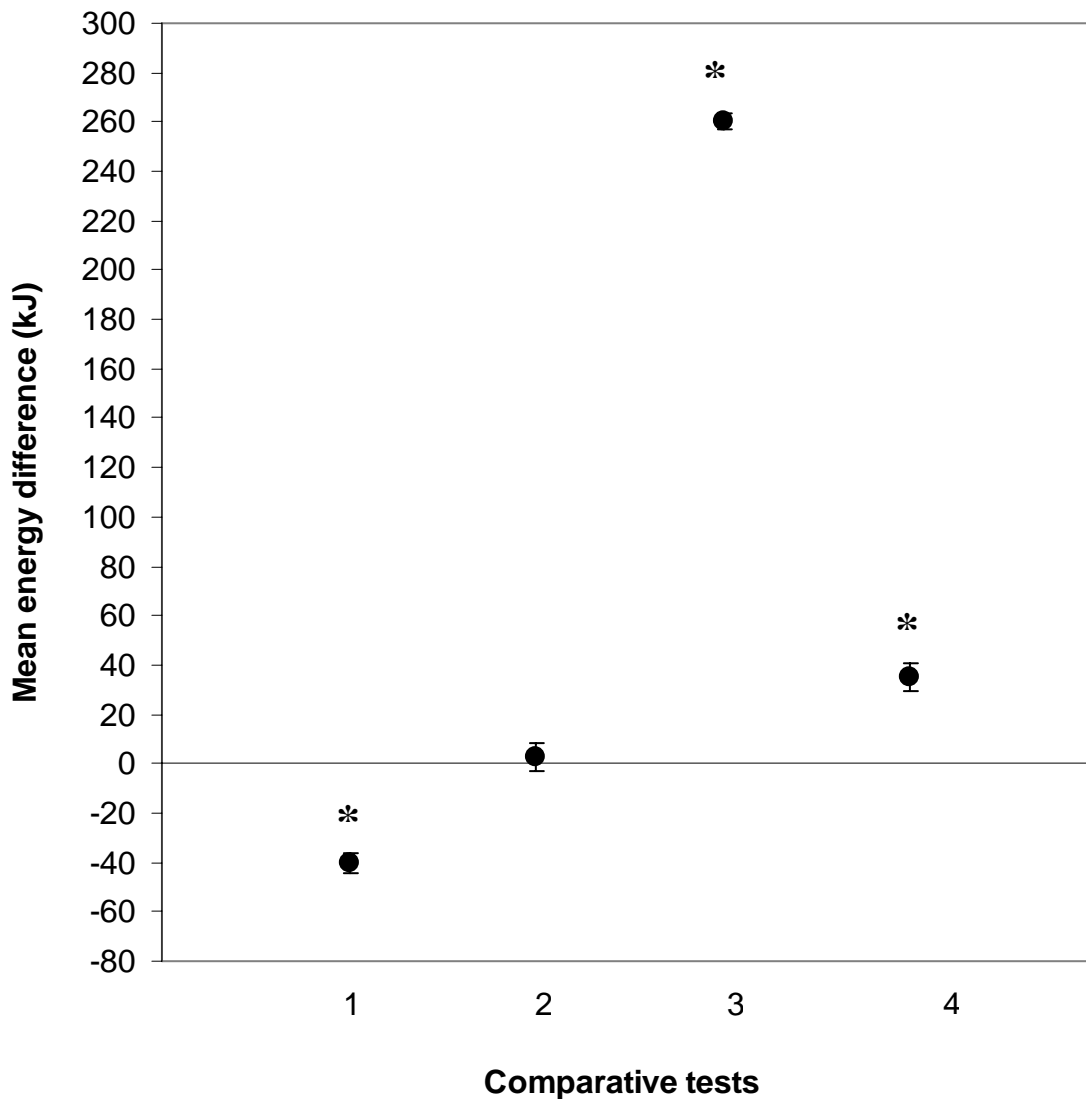

Figure 3.4. Mean energy difference and 95% confidence intervals from four independent sample t-tests which compared the energy budget of fish holding and non-fish holding Kittlitz's Murrelet under three vessel traffic scenarios: zero vessel (Z), average vessel (A) and maximum vessel (M) scenarios. Test 1: non-fish holder A vs. Z ( $Z > A$ ); Test 2: fish holder A vs. Z ( $A = Z$ ); Test 3: non-fish holder M vs. A ( $M > A$ ); Test 4: fish holder M vs. A ( $M > A$ ). Asterisks indicate significant t-test results.

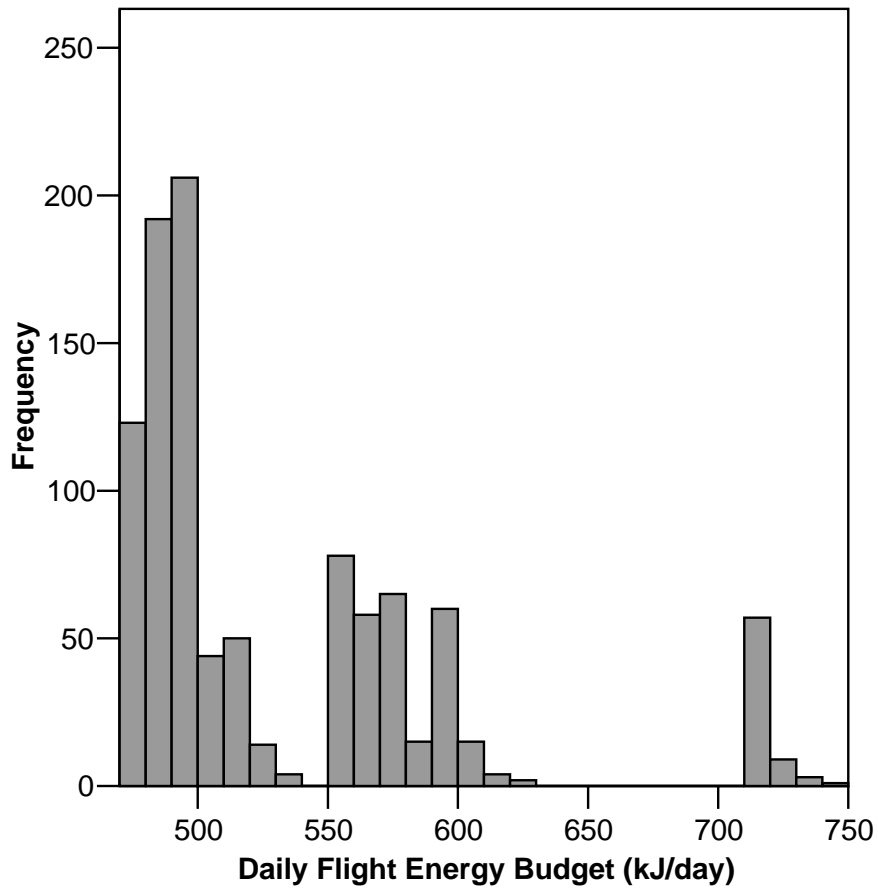

Figure 3.5. Distribution of model simulations for the fish holder average day scenario.

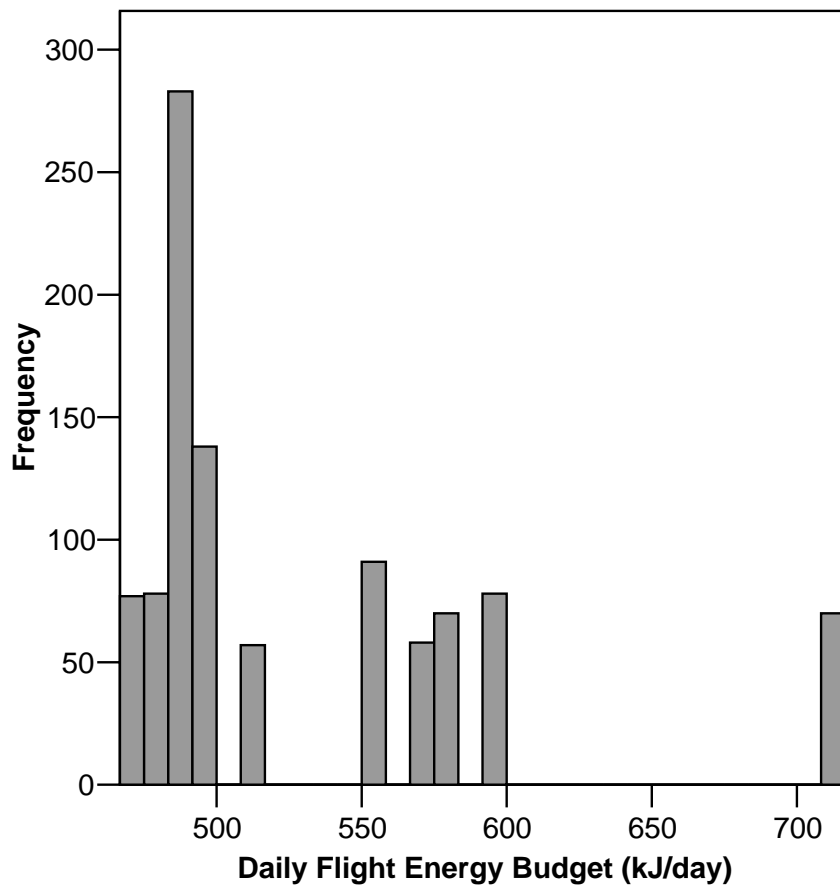

Figure 3.6. Distribution of model simulations for the best case scenario.

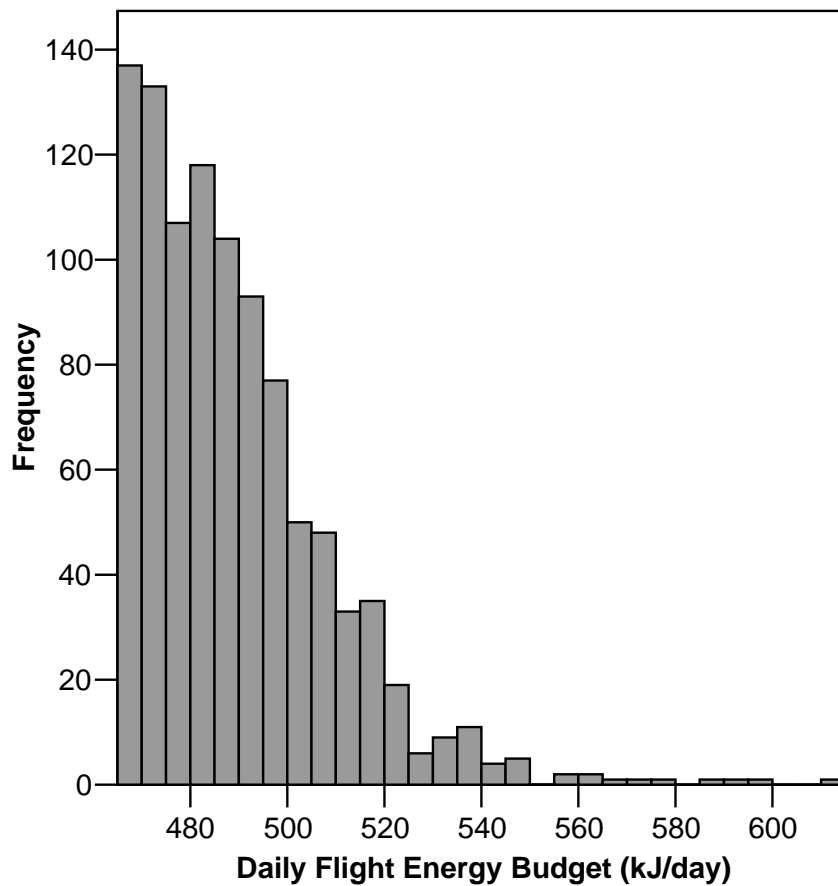

Figure 3.7. Distribution of model simulations for the non-fish holder average day scenario.



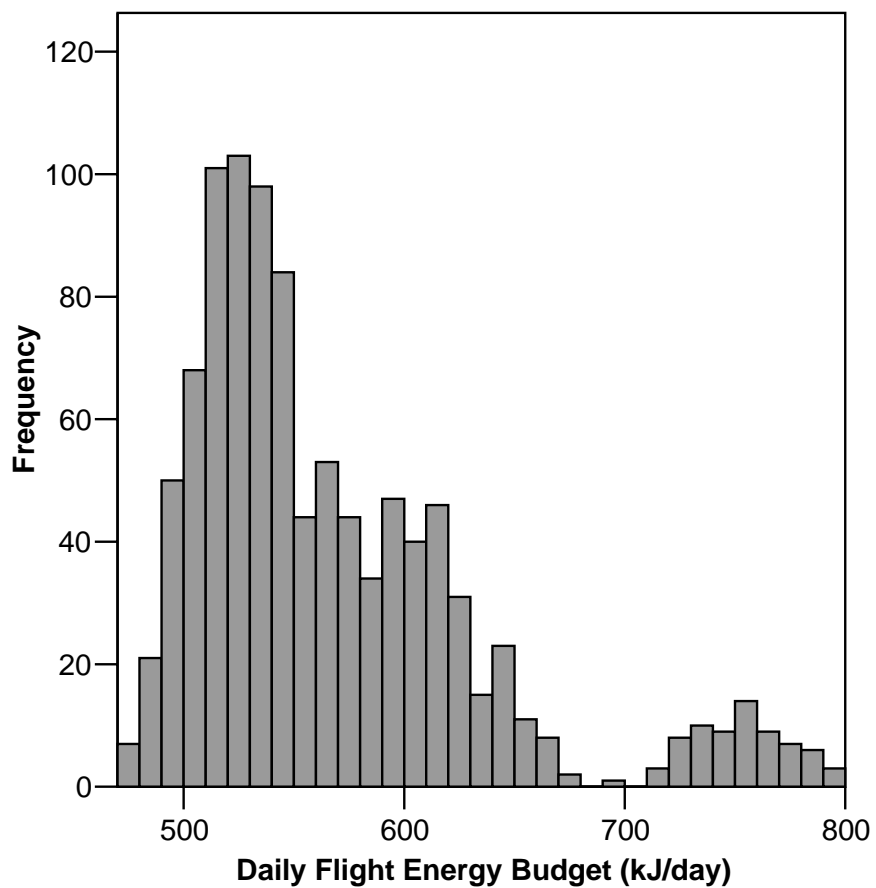

Figure 3.8. Distribution of model simulations for the fish holder worst case scenario.

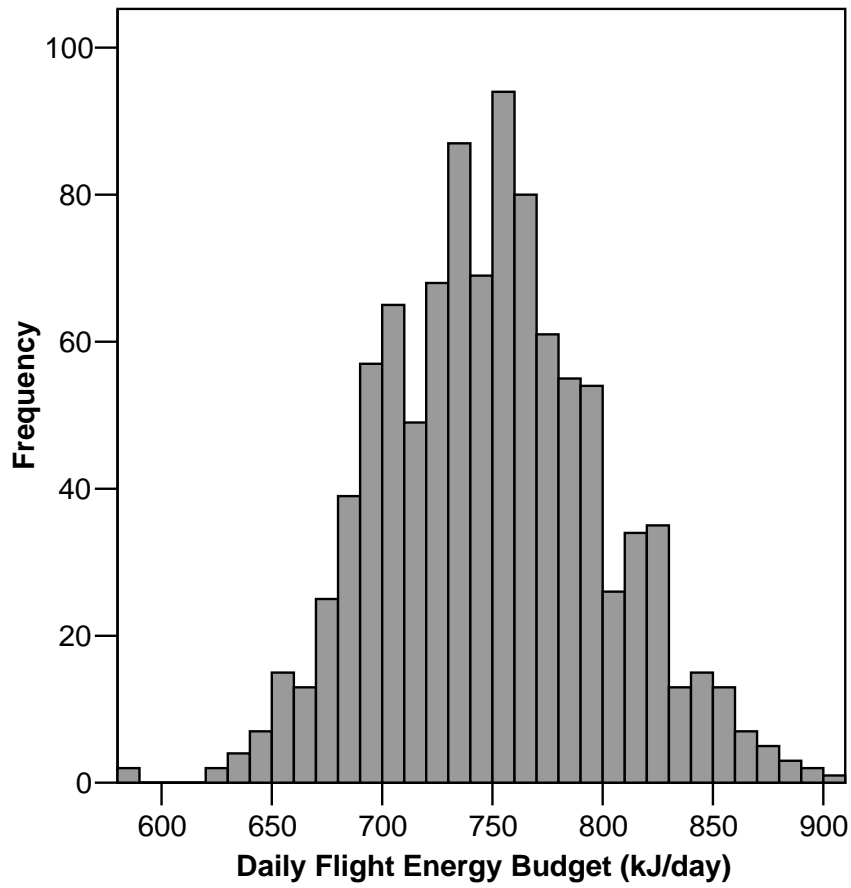

Figure 3.9. Distribution of model simulations for the non-fish holder worst case scenario

### Notes to Chapter 3

- Bailey, A.M., 1927. Notes on the birds of southeastern Alaska. *Auk* 44, 1-23.
- Bramford, A.R., S.J.J.F. Davies, and R. van Delft. 1990. The effects of model power boats on waterbirds at Herdsman lake, Perth, Western Australia. *Emu* 90: 260-265.
- Bratton, S.P. 1990. Boat disturbance of Ciconiiformes in Georgia estuaries. *Colonial Waterbirds* 13: 124-128.
- Bryant, D.M. and R.W. Furness. 1995. Basal metabolic rates of North Atlantic seabirds. *Ibis* 137: 219-226.
- Carter, H.R., S.G. Sealy. 1987. Fish-holding behavior of Marbled Murrelets. *Wilson Bulletin* 99: 289-291.
- Daan, S., C. Deerenberg, and C. Dijkstra. 1996. Increased daily work precipitates natural death in the Kestrel. *Journal of Animal Ecology* 65(5): 539-544.
- Day, R.H., K.J. Kuletz, and D.A. Nigro. 1999. Kittlitz's Murrelet (*Brachyramphus brevirostris*). in Poole, A. and Gill, F. (Eds.), *The Birds of North America*, No. 435. The Birds of North America, Inc., Philadelphia, PA.
- Day, R.H., A.K. Prichard, and D.A. Nigro. 2003. Ecological specialization and overlap of *Brachyramphus* murrelets in Prince William Sound, Alaska. *Auk* 120(3): 680-699.
- Day, R.H. and D.A. Nigro. 2000. Feeding ecology of Kittlitz's and Marbled Murrelets in Prince William Sound, Alaska. *Waterbirds* 23(1): 1-14.
- Day, R.H., K.L. Oakley, and D.R. Darnard. 1983. Nest sites and eggs of Kittlitz's and Marbled Murrelets. *Condor* 85: 265-273.
- Day, R.H. 1995. New information on Kittlitz's Murrelet nests. *Condor* 97: 271-273.
- Drent, R.H. and S. Dann. 1980. The prudent parent: energetic adjustments in avian breeding. *Ardea* 68: 225-252.
- Elliot, K.H., M. Hewett, G.W. Kaiser, and R.W. Blake. 2004. Flight energetics of the Marbled Murrelet, *Brachyramphus marmoratus*. *Canadian Journal of Zoology* 82: 644-652.
- Golet, G.H., J.A. Schmutz, D.B. Irons, and J.A. Estes. 2004. Determinants of reproductive costs in the long-lived Black-Legged Kittiwake: A multiyear experiment. *Ecological Monographs* 74(2): 353-372.

- Hall, C.M. 2001. Trends in ocean and coastal tourism: the end of the last frontier? *Ocean and Coastal Management* 44: 601-618.
- Hull, C.L., G.W. Kaiser, C. Lougheed, L. Lougheed, S. Boyd, and F. Cooke. 2001. Intraspecific variation in commuting distance of Marbled Murrelet (*Brachyramphus brevirostris*): Ecological and energetic consequences of nesting further inland. *Auk* 118(4): 1036-1046.
- Hodum, P.J., W.J. Sydeman, G. Henk Visser, and W.W. Weathers. 1998. Energy expenditure and food requirement of Cassin's Auklet provisioning nestlings. *Condor* 100: 546-550.
- Kaiser, M.S. and E.K. Fritzell. 1984. Effects of river recreationists on Green-Backed Heron behavior. *Journal of Wildlife Management* 48(2): 561-567.
- Keller, V.E. 1991. Effects of Human Disturbance on Eider Ducklings *Somateria mollissima* in an Estuarine Habitat in Scotland. *Biological Conservation* 58(2): 213-228.
- Korschgen, C.E., L.S. George, and W.L. Green. 1985. Disturbance of Diving Ducks by Boaters on a Migrational Staging Area. *Wildlife Society Bulletin* 13(3): 290-296.
- Kuletz, K.J., S.W. Stephensen, D.B. Irons, E.L. Labunski, and K.M. Brenneman. 2003. Changes in distribution and abundance of Kittlitz's Murrelets *Brachyramphus brevirostris* relative to glacial recession in Prince William Sound, Alaska. *Marine Ornithology* 31: 133-140.
- McEwen, B.S., J.C. Wingfield. 2003. The concept of allostasis in biology and biomedicine. *Hormone Behavior*. 43: 2-15.
- Mikola, J., M. Miettinen, E. Lehtikoinen, and K. Lehtila. 1994. The Effects of Disturbance Caused by Boating on Survival and Behavior of Velvet Scoter *Melanitta fusca* Ducklings. *Biological Conservation* 67(2): 119-124.
- Montevecchi, W.A. and J.F. Piatt. 1984. Composition and energy contents of mature inshore spawning capelin (*Mallotus villosus*): implications for seabird predators. *Comparative Biochemical Physiology A* 78: 15-20.
- Montevecchi, W.A. and J.F. Piatt. 1987. Dehydration of seabird prey during transport to the colony: Effects on wet weight energy densities. *Canadian Journal of Zoology* 65: 2822-2824.

- Naslund, N.L., J.F. Piatt, and T. van Pelt. 1994. Breeding behavior and nest site fidelity of Kittlitz's Murrelet. Abstracts of Pacific Seabird Group meeting, 26-29 January 1994: 33-34, Sacramento, CA.
- Pennycook, C.J. 1989. Bird flight performance: A practical calculation manual. Oxford University Press, New York.
- Piatt, J.F., N.L. Naslund, and T.I. van Pelt. 1994. Nest-site selection and fidelity in Kittlitz's Murrelet. *Beringian Seabird Bulletin* 2: 54-56.
- Pierce, G.J., C.J. Spray, E. Stuart. 1993. The Effect of Fishing on the Distribution and Behavior of Waterbirds in the Kukut Area of Lake Songkla, Southern Thailand. *Biological Conservation* 66(1): 23-34.
- Robards, M., G. Drew, J. Piatt, J. Anson, A. Abookire, J. Bodkin, P. Hoogie, and S. Speckman. 2003. Ecology of selected marine communities in Glacier Bay: Zooplankton, forage fish, seabirds and marine mammals. Final report to Glacier Bay National Park and Preserve (Gustavus, Alaska). USGS Alaska Science Center, Biological Science Office, Anchorage, Alaska.
- Rodgers, J.A. and S.T. Schwikert. 2002. Buffer-zone distances to protect foraging and loafing waterbirds from disturbance by personal watercraft and outboard-powered boats. *Conservation Biology* 16(1): 216-224.
- Rodgers, J.A. and S.T. Schwikert. 2003. Buffer zone distances to protect foraging and loafing waterbirds from disturbance by airboats in Florida. *Waterbirds* 26(4): 437-443.
- Rodgers, J.A., H.T. Smith, 1995. Set-Back Distances to Protect Nesting Bird Colonies from Human Disturbance in Florida. *Conservation Biology* 9(1), 89-99.
- Rodgers, J.A., Smith, H.T. 1997. Buffer zone distances to protect foraging and loafing waterbirds from human disturbance in Florida. *Wildlife Society Bulletin* 25(1): 139-145.
- Sanz, J.J., J.M. Tinbergen, J. Moreno, M. Orell, and S. Verhulst. 2000. Latitudinal variation in parental energy expenditure during brood rearing in the great tit. *Oecologia* 122: 149-154.
- Speckman, S.G., J.F. Piatt, A.M. Springer. 2003. Deciphering the social structure of marbled murrelets from behavioral observations at sea. *Waterbirds* 26: 266-274.
- Schummer, M.L. and W.R. Eddleman. 2003. Effects of disturbance on activity and energy budgets of migrating waterbirds in south-central Oklahoma. *Journal of Wildlife Management* 67(4): 789-795.

Strachan, G., M. McAllister, C.J. Ralph. 1995. Marbled Murrelet at-sea and foraging behavior. in C.J. Ralph, G.L. Hunt, Jr., M.G. Raphael and J.F. Piatt (Eds.), Ecology and conservation of the Marbled Murrelet. General Technical Report PSW-152. U.S. Department of Agriculture, Forest Service, Pacific Southwest Research Station, Albany, CA, pp. 247-253.

Tranquilla, L.M., N.R. Parker, R.W. Bradley, D.B. Lank, E.A. Krebs, L. Loughheed, and C. Loughheed. 2005. Breeding chronology of Marbled Murrelets varies between coastal and inshore sites in southern British Columbia. *Journal of Field Ornithology* 76(4): 357-367.

Traut, A.H. and M.E. Hostetler. 2003. Urban lakes and waterbirds: Effects of development on avian behavior. *Waterbirds* 26(3): 290-302.

van Vliet, G. 1993. Status concerns for the "global" population of Kittlitz's Murrelet: is the "glacier murrelet" receding? *Pacific Seabird Group Bulletin* 20: 15-16.

van Vliet, G. and M. Mc Allister. 1994. Kittlitz's Murrelet: the species most impacted by direct mortality from the Exxon Valdez oil spill? *Pacific Seabirds* 21: 5-6.

Walker, B.G., P.D. Boersma, J.C. Wingfield. 2005. Field endocrinology and conservation biology. *Intergr. Comparative Biology* 45: 12-18.

Wikelski, M. and S.J. Cooke. 2006. Conservation physiology. *Trends in Ecology and Evolution* 21(2): 38-46.

Wynee, K.M., D.L. Hicks, and N.R. Munro. 1992. 1991 Marine Mammal Observer Program for the salmon driftnet fishery of Prince William Sound, Alaska. Unpubl. report prepared for NOAA / NMFS, Alaska Region Office of Marine Mammals, Juneau, by Saltwater, Inc., Anchorage.

## CONCLUSION

In chapter 1, literature review revealed that research investigating bird-vessel interactions should include biological, environmental and vessel-related variables to identify the effects of vessel disturbance. In addition, a key message emerged from behavioral ecologists calling for the use of modeling as a problem solving tool in ecology. We followed by indeed including all aforementioned variable types in analyses, and proceeded with modeling efforts to evaluate the impacts of vessel disturbance to the Kittlitz's Murrelet in chapters 2 and 3.

We found that the major effects of vessel activity on the Kittlitz's Murrelet were behavioral in nature, such that the birds immediately flew from vessels. They flew 30 times more from vessels than in the absence of vessels. Vessel characteristics were found to mediate the probability of behavioral response in the Kittlitz's Murrelet. Our next step was to use modeling techniques to evaluate the energetic impacts of vessel disturbance. We found that average vessel traffic conditions in Glacier Bay likely did not impact the species flight energy budget, or were within their biological capacity to handle. Although the maximum vessel scenario of vessel traffic conditions in Glacier Bay were not likely to impact fish holders, they were likely to cause substantial risk of stress to non-fish holders.

When we evaluated the distribution percentiles of both worst and average case scenarios, we found consistent results. Our overall conclusions from these studies follow that the evaluation of behavioral effects and energetic impacts on sensitive species such as the Kittlitz's Murrelet are important considerations when deciding whether or not to inflate vessel quotas in Glacier Bay National Park and elsewhere.



## Bibliography

Altmann, J. 1974. Observational study of behavior: sampling methods. *Behaviour* 49(3-4): 227-267.

Arimitsu, M.L., J.F. Piatt, M.D. Romano, M.A. Litzow, A.A. Abbookire, and M. Robards. *In press*. Distribution and spawning dynamics of Pacific capelin (*Mallotus villosus*) in the nearshore and pelagic habitats of Glacier Bay National Park, Alaska. *Journal Name?*

Arimitsu, M.L., M.A. Litzow, J.F. Piatt, M.D. Robards, A.A. Abookire, and G.S. Drew. 2003. Inventory of marine and estuarine fishes in Southeast and Central Alaska National Parks. Nat. Park. Serv. Alaska Region. Inventory and Monitoring Program Final Rep., USGS Alaska Science Center, Anchorage, Alaska.

Arimitsu, M.L., and J.F. Piatt. 2004. Field guide to identifying Kittlitz's Murrelet forage fish. USGS Alaska Science Center, Anchorage, Alaska.

Arndt, A.A., K.A. Echelmeyer, W.D. Harrison, C.S. Lingle, and V.B. Valentine. 2002. Rapid wastage of Alaska glaciers and their contribution to rising sea level. *Science* 297: 382-386.

Batten, L.A. 1977. Sailing on reservoirs and its effects on water birds. *Biological Conservation* 11(1): 49-58.

Beale, C.M. and P. Monaghan. 2004. Human disturbance: people as predation-free predators? *Journal of Applied Ecology* 41(2): 335-343.

Belanger, L. and J. Bedard. 1989. Responses of Staging Greater Snow Geese to Human Disturbance. *Journal of Wildlife Management* 53(3): 713-719.

Bodkin, J.L., K.A. Kloecker, H.A. Coletti, G.G. Esslinger, D.H. Monson, B.E. Ballachey. 2001. Marine Predator Surveys in Glacier Bay National Park and Preserve. USGS-BRD annual report, 2001. Pp. 45.

Boyle, S.A. and F.B. Samson. 1985. Effects of Nonconsumptive Recreation on Wildlife - a Review. *Wildlife Society Bulletin* 13(2): 110-116.

Bramford, A.R., S.J.J.F. Davies, and R. van Delft. 1990. The effects of model power boats on waterbirds at Herdsman lake, Perth, Western Australia. *Emu* 90:260-265.

Bratton, S.P. 1990. Boat disturbance of Ciconiiformes in Georgia estuaries. *Colonial Waterbirds* 13: 124-128.

- Breiman, L., J.H. Friedman, R.A. Olshen, and C.G. Stone. 1984. Classification and regression trees. Wadsworth International Group, Belmont, California, USA.
- Brown, A.L. 1990. Measuring the Effect of Aircraft Noise on Sea Birds. *Environment International* 16(4-6): 587-592.
- Bryant, D.M. and R.W. Furness. 1995. Basal metabolic rates of North Atlantic seabirds. *Ibis* 137: 219-226.
- Burger, J. 1998. Effects of motorboats and personal watercraft on flight behavior over a colony of Common Terns. *Condor* 100(3): 528-534.
- Burger, J. and J. Galli. 1987. Factors Affecting Distribution of Gulls (*Larus* Spp) on 2 New-Jersey Coastal Bays. *Environmental Conservation* 14(1): 59-65.
- Carter, H. R. and S. G. Sealy. 1987. Fish-holding behavior of Marbled Murrelets. *Wilson Bulletin* 99:289-291.
- Carney, K.M. and W.J. Sydeman. 2000. "Response: Disturbance, habituation and management of waterbirds. *Waterbirds* 23(2): 333-334.
- Cincotta, R.P., J. Winewski, and R. Engleman. 2000. Human Population in the biodiversity hotspots. *Nature* 404: 990-992.
- Clark, C.W. and M. Mangel. 2000. *Dynamic State Variable Models in Ecology*. Oxford University Press, Oxford.
- Conomy, J.T., J.A. Dubovsky, J.A. Collazo, W.J. Fleming. 1998. Do black ducks and wood ducks habituate to aircraft disturbance? *Journal of Wildlife Management* 62(3): 1135-1142.
- Daan, S., C. Deerenberg, and C. Dijkstra. 1996. Increased daily work precipitates natural death in the Kestrel. *Journal of Animal Ecology* 65(5): 539-544.
- Day, R.H. 1995. New information on Kittlitz's Murrelet nests. *Condor* 97: 271-273.
- Day, R.H. 1996. Nesting phenology of Kittlitz's Murrelet. *Condor* 98: 433-437.
- Day, R. H., K. L. Oakley, and D. R. Darnard. 1983. Nest sites and eggs of Kittlitz's and Marbled Murrelets. *Condor* 85:265-273.
- Day, R.H., K.J. Kuletz, and D.A. Nigro. 1999. Kittlitz's Murrelet (*Brachyramphus brevirostris*). In *The Birds of North America*, No. 435 (A. Poole and F. Gill, eds.). The Birds of North America, Inc., Philadelphia, PA.

- Day, R.H., and D.A. Nigro. 2000. Feeding ecology of Kittlitz's and Marbled Murrelets in Prince William Sound, Alaska. *Waterbirds* 23(1): 1 – 14.
- Day, R.H., A.K. Prichard, and D.A. Nigro. 2003. Ecological specialization and overlap of *Brachyramphus* murrelets in Prince William Sound, Alaska. *Auk* 120(3): 680 – 699.
- De'ath, G., and K.E. Fabricius. 2000. Classification and regression trees: a powerful yet simple technique for ecological data analysis. *Ecology* 81(11): 3178-3192.
- De'ath, G. 2002. Multivariate regression trees: A new technique for modeling species-environment relationships. *Ecology* 83(4): 1105-1117.
- Delaney, D.K., T.G. Grubb, P. Beier, L.L. Pater, M.H. Reiser. 1999. Effects of helicopter noise on Mexican spotted owls. *Journal of Wildlife Management* 63(1): 60-76.
- Drent, R.H. and S. Daan. 1980. The prudent parent: energetic adjustments in avian breeding. *Ardea* 68: 225-252.
- Ehrlich, P.R. and J. Holdren. 1971. "The impact of population growth." *Science* 171: 1212-1217.
- Elliot, K.H., M. Hewett, G.W. Kaiser, and R.W. Blake. 2004. Flight energetics of the Marbled Murrelet, *Brachyramphus marmoratus*. *Canadian Journal of Zoology* 82: 644-652.
- Ely, C.R., D.H. Ward, and K. S. Bollinger. 1999. Behavioral correlates of heart rates of free-living Greater White-fronted Geese. *Condor* 101(2): 390-395.
- Foster, J.T., E.J. Tweed, R.J. Camp, B.L Woodworth, C.D. Adler, and T. Telfer. 2004. Changes of native and introduced birds in Alaka' i swamp, Kaua'i. *Conservation Biology* 18(3): 716-725.
- Frederiksen, M., M.P. Harris, F. Daunt, P. Rothery, and S. Wanless. 2004. Scale-dependent climate signals drive breeding phenology of three seabird species. *Global Climate Biology* 10: 1214-1221.
- Galicia, E. and G. A. Baldassarre. 1997. Effects of motorized tourboats on the behavior of nonbreeding American flamingos in Yucatan, Mexico. *Conservation Biology* 11(5): 1159-1165.
- Gill, J.A., W.J. Sutherland, and A.R. Watkinson. 1996. A method to quantify the effects of human disturbance on animal populations. *Journal of Applied Ecology*. 33(4): 786-792.

- Gill, J.A., K. Norris, and W. J. Sutherland. 2001. Why behavioural responses may not reflect the population consequences of human disturbance. *Biological Conservation* 97(2): 265-268.
- Golet, G.H., J.A. Schmutz, D.B. Irons, and J.A. Estes. 2004. Determinants of reproductive costs in the long-lived Black-Legged Kittiwake: A multiyear experiment. *Ecological Monographs* 74(2): 353-372.
- Grubb, T.G. and R.M. King. 1991. Assessing Human Disturbance of Breeding Bald Eagles with Classification Tree Models. *Journal of Wildlife Management* 55(3): 500-511.
- Hall, C.M. 2001. Trends in ocean and coastal tourism: the end of the last frontier? *Ocean and Coastal Management* 44: 601-618.
- Havera, S.P., L.R. Boens, et al. 1992. Human Disturbance of Waterfowl on Keokuk Pool, Mississippi River. *Wildlife Society Bulletin* 20(3): 290-298.
- Heckel, G., I. Espejel, and D.W. Fischer. 2003. Issue definition and planning for whale watching management strategies in Ensenada, Mexico. *Coastal Management* 31(3): 277-296.
- Hill, D., D. Hockin, D. Price, G. Tucker, R. Morris, and J. Treweek. 1997. Bird disturbance: Improving the quality and utility of disturbance research. *Journal of Applied Ecology* 34(2): 275-288.
- Hockin, D., M. Ounsted, M. Gorman, D. Hill, V. Keller, and M.A. Barker. 1992. Examination of the Effects of Disturbance on Birds with Reference to Its Importance in Ecological Assessments. *Journal of Environmental Management* 36(4): 253-286.
- Hodum, P.J., W.J. Sydeman, G. Henk Visser, and W.W. Weathers. 1998. Energy expenditure and food requirement of Cassin's Auklet provisioning nestlings. *Condor* 100: 546-550.
- Hull, C.L., G.W. Kaiser, C. Loughheed, L. Loughheed, S. Boyd, and F. Cooke. 2001. Intraspecific variation in commuting distance of Marbled Murrelet (*Brachyramphus brevirostris*): Ecological and energetic consequences of nesting further inland. *Auk* 118(4): 1036-1046.
- Hume, R.A. 1976. Reactions of Goldeneyes to boating. *British Birds* 69: 178-179.
- Kahl, R. 1991. Boating Disturbance of Canvasbacks During Migration at Lake Poygan, Wisconsin. *Wildlife Society Bulletin* 19(3): 242-248.

- Kaiser, M.S. and E.K. Fritzell. 1984. Effects of River Recreationists on Green-Backed Heron Behavior. *Journal of Wildlife Management* 48(2): 561-567.
- Keller, V.E. 1991. Effects of Human Disturbance on Eider Ducklings Somateria-Mollissima in an Estuarine Habitat in Scotland. *Biological Conservation* 58(2): 213-228.
- Kenow, K.P., C.E. Korschgen, J.M. Nissen, A. Elfessi, and R. Steinbach. 2003. A voluntary program to curtail boat disturbance to waterfowl during migration. *Waterbirds* 26(1): 77-87.
- Knapton, R.W., S.A. Petrie, and G. Herring. 2000. Human disturbance of diving ducks on Long Point Bay, Lake Erie. *Wildlife Society Bulletin* 28(4): 923-930.
- Knight, R.L. and S.K. Knight. 1984. Responses of Wintering Bald Eagles to Boating Activity. *Journal of Wildlife Management* 48(3): 999-1004.
- Korschgen, C.E., L.S. George, and W.L. Green. 1985. Disturbance of Diving Ducks by Boaters on a Migrational Staging Area. *Wildlife Society Bulletin* 13(3): 290-296.
- Kuletz, K.J., S.W. Stephensen, D.B. Irons, E.L. Labunski, and K.M. Brenneman. 2003. Changes in distribution and abundance of Kittlitz's Murrelets *Brachyramphus brevirostris* relative to glacial recession in Prince William Sound, Alaska. *Marine Ornithology* 31: 133-140.
- Kuletz, K.J. 1996. Marbled Murrelet Abundance and Breeding Activity at Naked Island, Prince William Sound, and Kachemak Bay, Alaska, before and after the *Exxon Valdez* Oil Spill. *American Fisheries Society Symposium* 18: 770-784.
- Kuletz, K.J., and S.J. Kendall. 1998. A productivity index for marbled murrelets in Alaska based on surveys at sea. *Journal of Wildlife Management* 62: 446-460.
- Lacroix, D.L., R.B. Lanctot, J.A. Reed, and T.L. McDonald. 2003. Effect of underwater seismic surveys on molting male Long-tailed Ducks in the Beaufort Sea, Alaska. *Canadian Journal of Zoology*. 81: 1862-1875.
- McEwen, B.S., J.C. Wingfield. 2003. The concept of allostasis in biology and biomedicine. *Hormone Behavior*. 43: 2-15.
- Mikola, J., M. Miettinen, E. Lehtikoinen, and K. Lehtila. 1994. The Effects of Disturbance Caused by Boating on Survival and Behavior of Velvet Scoter Melanitta-Fusca Ducklings. *Biological Conservation* 67(2): 119-124.

Montevecchi W.A. 1993. Birds as indicators of change in marine prey stocks. *In* Birds as monitors of environmental change. *Eds.* R. W. Furness and J. J. D. Greenwood. Chapman and Hall, London, U.K.

Montevecchi, W.A. and J.F. Piatt. 1984. Composition and energy contents of mature inshore spawning capelin (*Mallotus villosus*): implications for seabird predators. *Comparative Biochemical Physiology A* 78: 15-20.

Montevecchi, W.A., and J.F. Piatt. 1987. Dehydration of seabird prey during transport to the colony: Effects on wet weight energy densities. *Canadian Journal of Zoology* 65: 2822-2824.

Naslund, N.L., J.F. Piatt, and T. van Pelt. 1994. Breeding behavior and nest site fidelity of Kittlitz's Murrelet. Abstracts of Pacific Seabird Group meeting, 26-29 January 1994: 33-34, Sacramento, CA.

Naslund, N.L., and B.P. O'Donnell. 1995. Daily patterns of Marbled Murrelet activity at inland sites. Pages 129–134 in *Ecology and conservation of the Marbled Murrelet* (C.J. Ralph, G.L. Hunt, Jr., M.G. Raphael and J.F. Piatt, Eds.). General Technical Report PSW-152. U.S. Department of Agriculture, Forest Service, Pacific Southwest Research Station, Albany, CA.

Newton, I. 2004. The recent declines of farmland bird populations in Britain: an appraisal of causal factors and conservation actions. *Ibis* 146(4): 579-600.

Nisbet, I.C.T. 2000. Disturbance, habituation, and management of waterbird colonies - Commentary. *Waterbirds* 23(2): 312-332.

Norris, K., P.W. Atkinson, J.A. Gill. 2004. Climate change and coastal waterbird populations – past declines and future impacts. *Ibis* 146:82-98. Suppl. 1

Pennycuick, C.J. 1989. *Bird flight performance: A practical calculation manual*. Oxford University Press, New York.

Piatt, J.F., N.L. Naslund, and T.I. van Pelt. 1994. Nest-site selection and fidelity in Kittlitz's Murrelet. *Beringian Seabird Bulletin* 2: 54 – 56.

Piatt, J.F., and P. Anderson. 1996. Response of common murres to the Exxon Valdez oil spill and long-term changes in the Gulf of Alaska marine ecosystem. *In* Rice, S.D., Spies, R.B., Wolfe, D.A., Wright, B.A. (*Eds.*), *Proc. Exxon Valdez Oil Spill Symposium*, American Fisheries Society Symposium No. 18, American Fisheries Society, Bethesda, MD.

- Pierce, G.J., C.J. Spray, E. Stuart. 1993. The Effect of Fishing on the Distribution and Behavior of Waterbirds in the Kukut Area of Lake Songkla, Southern Thailand. *Biological Conservation* 66(1): 23-34.
- Reijnen, R., R. Foppen, C. Terbraak, and J. Thissen. 1995. The Effects of Car Traffic on Breeding Bird Populations in Woodland .3. Reduction of Density in Relation to the Proximity of Main Roads. *Journal of Applied Ecology* 32(1): 187-202.
- Rivera J. 2004. Institutional pressures and voluntary environmental behavior in developing countries: Evidence from the Costa Rican hotel industry. *Society and Natural Resources* 17(9): 779-797.
- Robards, M., G. Drew, J. Piatt, J. Anson, A. Abookire, J. Bodkin, P. Hoogie, and S. Speckman. 2003. Ecology of selected marine communities in Glacier Bay: Zooplankton, forage fish, seabirds and marine mammals. Final report to Glacier Bay National Park and Preserve (Gustavus, Alaska). USGS Alaska Science Center, Biological Science Office, Anchorage, Alaska.
- Robinson, J.A. and M.S. Pollitt. 2002. Sources and extent of human disturbance to waterbirds in the UK: an analysis of Wetland Bird Survey data, 1995/96 to 1998/99. *Bird Study* 49: 205-211.
- Rodgers, J.A. and S.T. Schwikert. 2002. Buffer-zone distances to protect foraging and loafing waterbirds from disturbance by personal watercraft and outboard-powered boats. *Conservation Biology* 16(1): 216-224.
- Rodgers, J.A. and S.T. Schwikert. 2003. Buffer zone distances to protect foraging and loafing waterbirds from disturbance by airboats in Florida. *Waterbirds* 26(4): 437-443.
- Rodgers, J.A. and H.T. Smith. 1995. Set-Back Distances to Protect Nesting Bird Colonies from Human Disturbance in Florida. *Conservation Biology* 9(1): 89-99.
- Rodgers, J.A. and H.T. Smith. 1997. Buffer zone distances to protect foraging and loafing waterbirds from human disturbance in Florida. *Wildlife Society Bulletin* 25(1): 139-145.
- Ronconi, R.A. and C.C. St Clair. 2002. Management options to reduce boat disturbance on foraging black guillemots (*Cepphus grylle*) in the Bay of Fundy. *Biological Conservation* 108(3): 265-271.
- Sanz, J.J., J.M. Tinbergen, J. Moreno, M. Orell, and S. Verhulst. 2000. Latitudinal variation in parental energy expenditure during brood rearing in the great tit. *Oecologia* 122: 149-154.

Schueck, L.S. and J.M. Marzluff. 1995. Influence of Weather on Conclusions About Effects of Human Activities on Raptors. *Journal of Wildlife Management* 59(4): 674-682.

Schummer, M.L. and W.R. Eddleman. 2003. Effects of disturbance on activity and energy budgets of migrating waterbirds in south-central Oklahoma. *Journal of Wildlife Management* 67(4): 789-795.

Sealy, S.G. 1974. Breeding phenology and clutch size in the Marbled Murrelet. *Auk* 91: 10-23.

Sisk, T.D., A.E. Launer, K.R. Switky, and P.R. Ehrlich. 1994. Identifying extinction threats. *Bioscience* 44:592-603.

Speckman, S.G., J.F. Piatt, and A.M. Springer. 2003. Deciphering the social structure of Marbled Murrelets from behavioral observations at sea. *Waterbirds* 26(3): 266-274.

Speckman, S. G., J. F. Piatt, and A. M. Springer. 2004. Small boats disturb fish-holding Marbled Murrelets. *Northwest Naturalist* 85:32-34.

Starfield, A.M. 1997. A pragmatic approach to modeling for wildlife management. *Journal of Wildlife Management*. 61(2): 261-270.

Stolen, E.D. 2003. The effects of vehicle passage on foraging behavior of wading birds. *Waterbirds* 26(4): 429-436.

Strachan, G., M. McAllister, and C. J. Ralph. 1995. Marbled Murrelet at-sea and foraging behavior. Pages 247–253 in *Ecology and conservation of the Marbled Murrelet* (C.J. Ralph, G.L. Hunt, Jr., M.G. Raphael and J.F. Piatt, Eds.). General Technical Report PSW-152. U.S. Department of Agriculture, Forest Service, Pacific Southwest Research Station, Albany, CA.

Sutherland, W.J. 1996. *From Individual Behaviour to Population Ecology*. Oxford University Press, Oxford.

Titus, J.R. and L.W. Vandruff. 1981. Response of the Common Loon to Recreational Pressure in the Boundary Waters Canoe Area, Northeastern Minnesota." *Wildlife Monographs* 79: 6-58.

Tranquilla, L.M., N.R. Parker, R.W. Bradley, D.B. Lank, E.A. Krebs, L. Loughheed, and C. Loughheed. 2005. Breeding chronology of Marbled Murrelets varies between coastal and inshore sites in southern British Columbia. *Journal of Field Ornithology* 76(4): 357-367.



- Traut, A.H. and M.E. Hostetler. 2003. Urban lakes and waterbirds: Effects of development on avian behavior. *Waterbirds* 26(3): 290-302.
- Tuite, C.H., P.R. Hanson, and M. Owen. 1984. Some Ecological Factors Affecting Winter Wildfowl Distribution on Inland Waters in England and Wales, and the Influence of Water-Based Recreation. *Journal of Applied Ecology* 21(1): 41-61.
- van Vliet, G. 1993. Status concerns for the “global” population of Kittlitz’s Murrelet: is the “glacier murrelet” receding? *Pacific Seabird Group Bulletin* 20: 15-16.
- van Vliet, G. and M. Mc Allister. 1994. Kittlitz’s Murrelet: the species most impacted by direct mortality from the Exxon Valdez oil spill? *Pacific Seabirds* 21: 5-6.
- Walker, B.G., P.D. Boersma, J.C. Wingfield. 2005. Field endocrinology and conservation biology. *Intergr. Comparative Biology* 45: 12-18.
- Ward, D.H., R.A. Stehn, W.P. Erickson, and D.V. Derksen. 1999. Response of fall-staging brant and Canada geese to aircraft overflights in southwestern Alaska. *Journal of Wildlife Management* 63(1): 373-381.
- West, A.D., J.D. Goss-Custard, R.A. Stillman, R.W.G. Caldow, S.E.A.L.D. Durell, and S. McGrorty. 2002. Predicting the impacts of disturbance on shorebird mortality using a behaviour-based model. *Biological Conservation* 106(3): 319-328.
- Wikelski, M. and S.J. Cooke. 2006. Conservation physiology. *Trends in Ecology and Evolution* 21(2): 38-46.
- Wood, P.B. 1999. Bald Eagle Response to Boating Activity in Northcentral Florida. *Journal of Raptor Research* 33(2): 97-101.
- Wynee, K.M., D.L. Hicks, and N.R. Munro. 1992. 1991 Marine Mammal Observer Program for the salmon driftnet fishery of Prince William Sound, Alaska. Unpubl. report prepared for NOAA / NMFS, Alaska Region Office of Marine Mammals, Juneau, by Saltwater, Inc., Anchorage.
- Zar, J.H. 1999. *Biostatistical analysis*. 4<sup>th</sup> edition. Prentice Hall, New Jersey, USA.

**Appendix A. Using at-sea observations of fish holding Kittlitz's Murrelet (*Brachyramphus brevirostris*) to assess breeding phenology and chick diet****Summary**

The Kittlitz's Murrelet nests and forages in close association with glaciers in Alaska. Nesting locations of Kittlitz's are remote and nesting dispersed, and therefore little is known about the breeding ecology of this mysterious seabird. This species is a candidate for listing under the U.S. Endangered Species Act, because of substantial population declines in recent decades. Most of what we know about the species is derived from observations of birds' at-sea. Kittlitz's Murrelet hold fish cross-wise in the bill for later delivery to chicks in the nest, and this behavior provides an indirect source of information about breeding phenology and chick-provisioning. Observation of fish-holding behavior in Glacier Bay, Alaska, suggests that Kittlitz's chick-rearing occurs between 21 June and 15 July in SE Alaska. Capelin (39.7%), Pacific sandlance (31.0%), and Pacific herring (25.8%) were the most important forage fish species to chick-provisioning. Two environmental factors, time of day and near-shore habitat type, influenced the prevalence of fish-holding behavior, and potentially the frequency of occurrence of forage fish species for provisioning. Additionally, Kittlitz's fish-holders are most frequently isolated, and do not tend to form flocks with other birds.

## **Introduction**

The Kittlitz's Murrelet (*Brachyramphus brevirostris*) is a sub-arctic seabird that breeds from Southeastern Alaska to the Russian Far East (Day et al. 1999). The species has declined by as much as 90% in core breeding areas in recent decades (Robards et al. 2003, Drew and Piatt unpubl. data), and reasons for this decline are currently unknown. Also known as the glacier murrelet, Kittlitz's Murrelets nest and forage close to glaciated areas in Alaska (Day et al. 1999). They nest solitarily on recently deglaciated montane slopes. Their extreme nesting habitat and low nesting density hinder efforts to locate nests, and therefore little is known about their breeding biology. The breeding phenology of the Kittlitz's Murrelet has been estimated for most areas of its breeding range (Day 1996, Day et al. 1999). Owing to a scarcity of nesting data, however, regional estimates of phenology are inferred from Marbled Murrelet (*Brachyramphus marmoratus*; MAMU) breeding biology and a small set of Kittlitz's Murrelet nesting records (n=18, Day et al. 1983, Day 1995, Day 1996, Naslund et al. 1994, Piatt et al. 1994). Incubation period of Kittlitz's Murrelet is estimated at 30 days, based on the incubation period of the Marbled Murrelet (Sealy 1974, Day 1996). The chick-rearing period is known from a single Kittlitz's nest to be 24 days (Naslund et al. 1994, Day et al. 1999).

Because of their reclusive nesting habits, most information on population trends, distributions, and feeding ecology of KIMU is derived from observations at-sea. Fish-

holding is a behavior common to both Marbled and Kittlitz's murrelets, with individuals holding single fish cross-wise in the bill (Carter and Sealy 1987, Strachan et al. 1995). Adult fish-holders stage on the water and generally wait until night-fall before returning to the nest to deliver the fish to the chick (Carter and Sealy 1987, Strachan et al. 1995). By monitoring the frequency of fish-holding over time, one can estimate the peak of chick-rearing (Kuletz and Kendall 1998, Speckman et al. 2003, Tranquilla et al. 2005), as well as identify important prey in the diet of chicks (Speckman et al. 2003).

Environmental factors, such as near-shore habitat type and time of day may influence both the presence and behavior of murrelets. Kittlitz's prefer glacially-influenced marine habitat (Day and Nigro 2000, Day et al. 2003). Time of day influences the frequency of fish-holding behavior in both murrelet species, with fish-holding behavior more commonly observed during the evening hours (Speckman et al. 2003). Fish are commonly delivered to chicks before sunrise and after sunset (Naslund and O'Donnell 1995, Naslund et al. 1994).

Social dynamics also shape the behavior of murrelets at-sea. For example, Marbled Murrelets appear to use a cooperative foraging strategy, whereby small groups (typically 2) can herd a school of fish underwater to increase the time schools remain available as prey (Strachan et al. 1995, Speckman et al. 2003). Although Kittlitz's are thought to be less social than Marbled Murrelets (mean group size: 1.4 vs. 1.7 respectively, from Day et al. 1999) small groupings of Kittlitz's likely employ similar cooperative foraging

strategies to those described for the Marbled Murrelet. Fish-holders are a special case of Kittlitz's, which may stage with a held fish for hours before flying away to the nest, therefore, it is likely that social dynamics differ for fish-holders.

In this paper, we address three primary objectives: (1) We used the frequency of fish-holding behavior as a proxy of breeding status in order to estimate breeding phenology; (2) We identified species of fish held by Kittlitz's and consider the relative importance of fish species in chick provisioning; (3) We evaluated the environmental factors and social dynamics most conducive to fish-holding behavior.

## **Methods**

Kittlitz's Murrelets were observed at-sea in Glacier Bay, Alaska, from May through July, 2004. Seven sites were selected within the bay, and Kittlitz's were observed during available daylight hours (n=41 days, 9-11 h/day). Sites were selected based on previous observations of murrelets in Glacier Bay, Alaska (Piatt unpubl. data). The seven observation sites represent two near-shore habitat types: glacially influenced (proximity to tidewater glacier or glacial stream, n=4 sites), and not glacially influenced (n=3 sites).

Data were collected on species (Kittlitz's, Marbled or unidentified murrelet), group size, and behavior (loafing, diving, flying, and fish-holding) every half hour by use of scan sampling (Altman 1974). Murrelet groups were defined as singles, pairs and flocks. A

flock of murrelets was defined as three or more birds in proximity that maintain formation during movement or activity (Strachan et al.1995). Data were recorded on Palm m150 (Palm, Inc., Sunnyvale, CA, USA) handheld devices using behavioral software developed specifically for our scan sampling protocol. An average near-shore water surface area of  $3.44 \pm 0.52 \text{ km}^2$  was systematically scanned for murrelets at each site. Only data for known Kittlitz's Murrelet fish-holders were used in the analyses presented here. A forage fish identification key, developed to identify fish held cross-wise in the bill (Arimitsu and Piatt 2004), was used to identify fish held by Kittlitz's Murrelet.

Most fish (77% of fish held, n=189 of 247) could not be identified to species, because of variable observation conditions. We are confident that the identified fish (23% of fish held) are an unbiased sample of the total fish-holding population that we observed. Optimum light conditions and proximity to individual birds were required to obtain positive fish identification. When we could determine that fish were consumed by birds, we excluded those fish from analysis of prey types destined for delivery to chicks.

*Statistical analyses.*— Observations of fish-holding Kittlitz's at-sea were enumerated such that the number of fish-holders per day represented the maximum fish-holder count of all scans on a given sampling day. The cumulative frequency was calculated to provide an index of the number of adult birds that should be feeding chicks (for similar methodology see Jones 1992). The inflection point (50<sup>th</sup> percentile of the cumulative frequency data)

of the resultant logistic curve represents the estimated median chick-rearing date. Because data collection ended before fish-holding (i.e. chick-rearing) ended, the cumulative frequency of fish-holding did not level off during the study period. To extrapolate the maximum value, we fit a curve to the data (SPSS 12.0, Chicago, IL USA). A best logistic model fit was determined by evaluating the adjusted  $R^2$  value of models with successive upper bound values.

Frequency of occurrence of forage fish species was summarized to determine the relative importance of different fish species in diets, and the differences were tested using  $\chi^2$  (SPSS 12.0, Chicago, IL, USA). Similarly, in order to examine the social dynamics conducive to fish-holding, we summarize and test the frequency of occurrence of KIMU fish-holding observations by group size, and the occurrence of fish-holder groups vs. non-fish-holder groups with  $\chi^2$ .

Near-shore habitat types were not sampled equally during the determined chick-rearing period. Therefore, it was necessary to evaluate the abundance of fish-holders per habitat type using a relative measure of observation effort. We calculated the average daily rate of fish-holders per habitat type (glacial: n=222 fish-holders, and non-glacial: n=25 fish-holders) across the number of observation days during the chick-rearing period for each habitat type (glacial: 27, non-glacial: 5). We used a t-test ( $\alpha = 0.05$ ) to determine whether habitat type was a significant predictor of fish-holder abundance.

To address the importance of time of day to patterns of Kittlitz's Murrelet fish-holding behavior, we summarize observation of Kittlitz's fish-holders by three time categories: morning (0400–0900), mid-day (0900–1800), and evening (1800–2300). As near shore habitat type influenced the prevalence of Kittlitz's Murrelet fish-holders, we sub-categorized the frequency of fish-holders for time of day and habitat type. One-way and likelihood-ratio  $\chi^2$  were used to test for statistical significance.

## Results

The cumulative frequency of the number of fish-holding Kittlitz's versus date was non-linear (Fig. 1). We modeled the relationship with a logistic curve, and derived the following equation.

$Y = 1 / ((1/95) + 70881.577 * (0.91824^{**X}))$ , where Y= frequency of fish-holders, X= date, and 95 is the upper bound value, units are n, the number of Kittlitz's fish-holders.

Median hatch date predicted from the logistic model was 3 July. Therefore, recalling that the chick-rearing period is 24 days (Naslund et al. 1994), we added 12 days to either side of 3 July, to determine the peak of chick-rearing (21 June through 15 July). By extrapolation, the peak of incubation was May 23 through June 21, and the peak of fledge initiated on 15 July.



The three most important fish species to provisioning efforts are capelin, Pacific sandlance, and Pacific herring ( $\chi^2= 50.3$ ,  $df= 1$ ,  $p < 0.0001$ ) (Table 1), accounting for 96.5% of fish observed. There was a marginal difference in fish-holding behavior between habitat types ( $t= 2.03$ ,  $df=21.8$ ,  $p= 0.055$ ). Glacially-affected habitat supported greater numbers of fish-holders during chick-rearing ( $\bar{x} = 8 \pm 2.1$  fish-holders/ day) than were found in glacially-unaffected habitat ( $\bar{x} = 2.8 \pm 1.5$  fish-holders/ day). Capelin were held more commonly by Kittlitz's Murrelets staging in glacial habitat, while Pacific Sandlance were held more commonly in non-glacial habitat (marginally significant) (Likelihood ratio  $\chi^2= 7.290$ ,  $p= 0.063$ ; Table 2).

Time of day was a significant predictor of fish holding behavior overall (one-way  $\chi^2= 55.5$ ,  $df= 2$ ,  $p < 0.000$ ), and within habitat types (glacial: one-way  $\chi^2= 54.6$ ,  $df= 2$ ,  $p < 0.000$ ; non-glacial: one-way  $\chi^2= 6.32$ ,  $df= 2$ ,  $p= 0.042$ ) (Table 3). Diurnal patterns of fish-holding did not differ between habitat types (glacial vs. non-glacial: Likelihood ratio  $\chi^2=4.52$ ,  $p= 0.104$ ). For both habitat types, fish holding behavior occurs most often in mid-day and evening hours (glacial: one-way  $\chi^2= 136.4$ ,  $df= 1$ ,  $p < 0.000$ ; non-glacial: one-way  $\chi^2= 11.6$ ,  $df= 1$ ,  $p= 0.001$ ).

Most Kittlitz's that were holding fish were encountered as single birds (73.7%; one-way  $\chi^2= 69.02$ ,  $df= 1$ ,  $p < 0.0001$ ), and large groups of 2-10 birds were observed less

frequently (Fig. 2). On average, fish-holders are found in smaller groupings (1.4) than non fish-holders (1.9), providing further evidence of social isolation by fish-holders ( $t=5.867$ ,  $df=34.6$ ,  $p < 0.0001$ ). Where group size was greater than one, fish-holders were sometimes encountered among other fish-holders, but usually larger group sizes represent groupings of a single fish-holder with non-fish-holders. Group size of fish-holding Kittlitz's did not vary by near-shore habitat type.

## **Discussion**

It is difficult to assess breeding phenology for the Kittlitz's Murrelet; however, adult delivery of food appears to be a practical method (Speckman et al. 2003, Jones 1992). Our breeding chronology estimates for chick-rearing (21 Jun – 15 Jul) are within days of estimates previously derived by Day (1996) for Southeastern Alaska (14 Jun–14 Jul). An estimate of Marbled Murrelet phenology in Southeastern Alaska that also used fish-holder observations included a similar time span for chick rearing (Speckman et al. 2003). Accurate estimates of breeding phenology are important to long-term monitoring of seabird populations. For example, differences in phenology over time may relate to changes in the environment, food supply, and seabird productivity (Montevecchi 1993, Piatt & Anderson 1996, Frederickson et al. 2004). Because the Kittlitz's Murrelet is a candidate species for U.S. federal Endangered Species Act listing, and has undergone severe population declines in recent decades (Robards et al. 2003, Drew and Piatt unpubl. data), an understanding of breeding phenology is critical to understanding and monitoring

the species status. It is especially important considering the current period of glacial recession (Arndt et al. 2002), and potential consequences of this environmental change to Kittlitz's, the glacier murrelet.

Our study provides an initial step to assess chick diet, and the relative importance of forage fish species to chick provisioning. The only other study which contains chick diet information for Kittlitz's comes from video footage of a single active nest in Kachemak Bay, Alaska (Naslund et al. 1994). The Kachemak Bay chick was primarily fed Pacific sandlance (67% of 33 prey items), followed by capelin (18%), and unidentified fishes (15%). In contrast, our study found more equal use of capelin (39.7% of 58 prey), Pacific sandlance (31.0%) and Pacific herring (25.8%) for the fish-holder population observed in Glacier Bay, Alaska. A study of Marbled Murrelet fish-holders, however, found greater preference for Pacific sandlance (40% of 203 prey), than for capelin (3%) or Pacific herring (2%) (51% unidentified) (Speckman et al. 2003). The primary prey species (Pacific sandlance, capelin and Pacific herring) for Kittlitz's and Marbled Murrelet chicks in Glacier Bay, Kachemak Bay, and Auke Bay, Alaska, have high energy density, supporting the hypothesis that seabirds base prey choice in part on energy density (Anthony et al. 2000).

Glacially affected areas are important staging and foraging grounds for provisioning Kittlitz's Murrelets. Fish-holding behavior was relatively more likely ( $p=0.055$ ) to occur in glacial areas. The greater occurrence of fish-holders in glacial habitat may reflect the

shorter flight distance to nesting habitat or food availability. For example, capelin, a preferred prey item for Kittlitz's chicks, tends to aggregate in glacial waters within Glacier Bay (Arimitsu et al. *in press*). Availability likely contributes to the difference in relative importance of fish species by habitat type ( $p=0.063$ ), recalling that capelin were selected more often in glacial habitat as chick-meals. The composition of prey species in Glacier Bay was estimated by catch per unit effort (CPUE # fish/km trawled) (Arimitsu et al. 2003). Of the four most abundant forage fish species (capelin [57.9], walleye pollock [47.3], northern smoothtongue [9.1], and northern lampfish [6.1]), only capelin were preferred by Kittlitz's. This indicates that a combination of availability and quality of prey are important factors to the Kittlitz's Murrelet during provisioning.

It is critical for the Kittlitz's Murrelet to get held fish to the nest. We found that fish-holding behavior occurred predominantly during mid-day and evening hours; however, most provisioning murrelets wait until dusk to return to the nest. This means there is substantial time spent staging on the water with a held fish. Time invested in individual chick-meals emphasizes that Kittlitz's can not afford to lose these fish. Fish-holders were most often found as singles on the water; therefore, social isolation may be advantageous to protect the chick-meal. Fish-holders may prefer to isolate themselves from other birds in an attempt to safeguard against kleptoparasitism. On one occasion (3 July 2004), kleptoparasitism of a fish-holding Kittlitz's Murrelet was observed. The group size was five, and two fish-holding Kittlitz's were present in the group. A non-fish holder successfully stole the held fish of one fish-holding bird in the group; after which

the fish-holding bird, minus its fish, maintained position in the group. Fish-holders are also potentially disturbed by the approach of vessels (Speckman et al. 2004, Agness unpubl. data), further indicating that isolation from birds as well as vessels is likely beneficial to protect chick-meals, and ensure successful delivery of fish.

Table A.1. Frequency of occurrence of fish species that were positively identified (n=58 of 247) in the bill of Kittlitz's holding fish.

Fish Species	Frequency of Occurrence
Capelin ( <i>Mallotus villosus</i> )	39.7%
Pacific Sandlance ( <i>Ammodytes hexapterus</i> )	31.0%
Pacific Herring ( <i>Clupea harengus</i> )	25.8%
Pacific Salmon spp. ( <i>Oncorhynchus</i> spp.)	3.4%*

\* Pacific Salmon occurred at significantly lower frequency than other species.

Table A.2. Frequency of occurrence of positively identified fish species held by Kittlitz's in glacial (n=51 of 222) vs. non-glacial (n=7 of 25) near shore habitat types.

Habitat	Fish Species	Frequency of Occurrence
Glacial	Capelin	41.1%
	Pacific Herring	29.4%
	Pacific Sandlance	27.5%
	Salmon spp.	2.0%
Non-Glacial	Pacific Sandlance	57.1%
	Capelin	28.6%
	Salmon spp.	14.3%

Table A.3. Frequency of occurrence of fish-holding behavior (n=247) observed for three times of day: morning, mid-day and evening.

Habitat	Time of Day	Frequency of Occurrence
Glacial (n=222)	morning*	11%
	mid-day	39%
	evening	50%
Non-Glacial (n=25)	morning*	16%
	mid-day	56%
	evening	28%

\* For both glacial and non-glacial habitats, fish holding behavior is significantly less likely to occur in morning than during mid-day or evening hours.



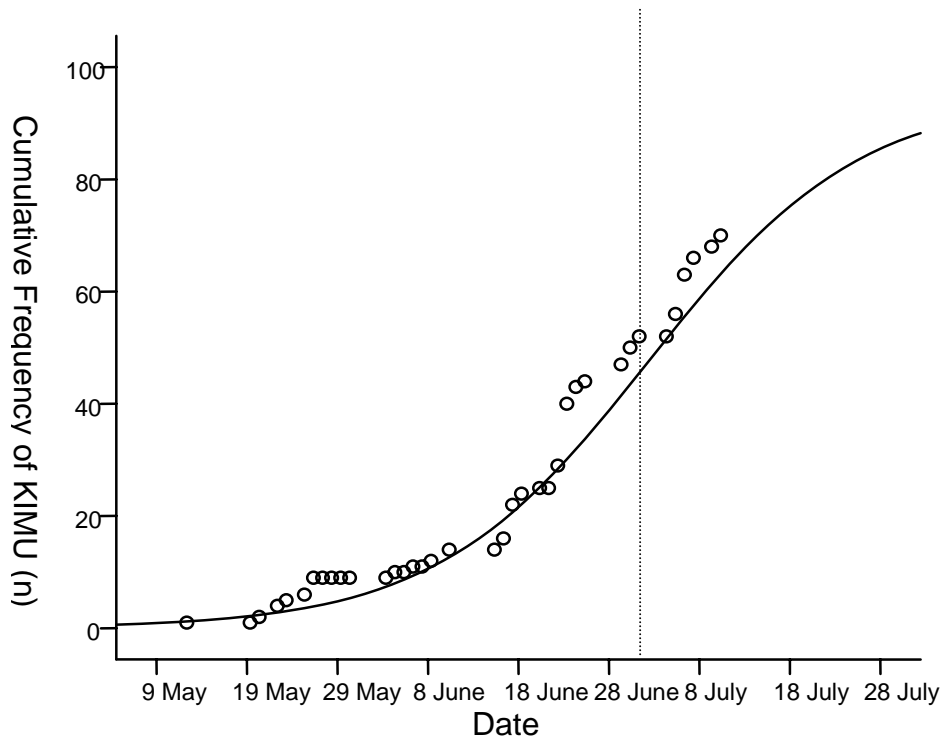

Figure A.1. The cumulative frequency of Kittlitz's Murrelet fish-holding behavior observed across the dates of study. A logistic curve is fitted to the data-set. The vertical dashed line indicates the inflection point (3 July) of the logistic regression curve.

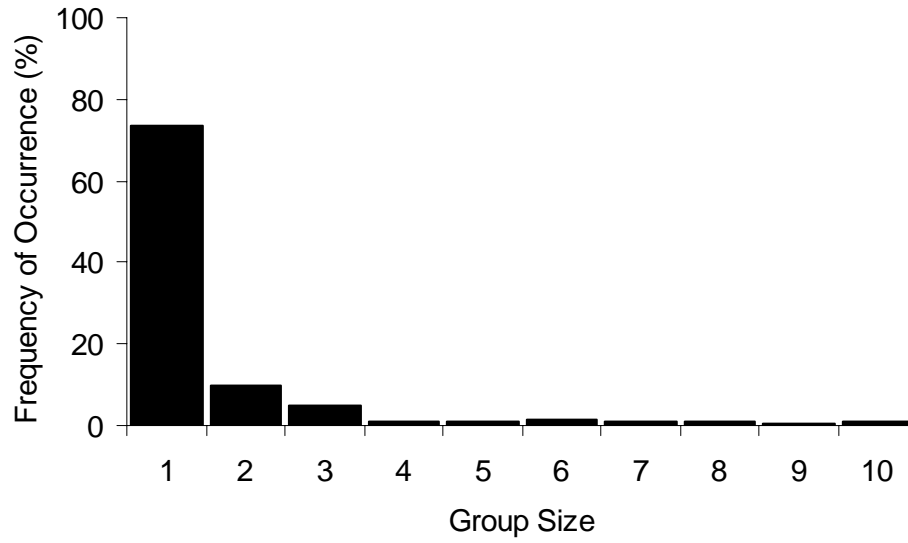

Figure A.2. Frequency of occurrence of fish-holding behavior by birds in flocks of different size (n=247).

## Notes to Appendix A

Altmann, J. 1974. Observational study of behavior: sampling methods. *Behaviour* 49(3-4): 227-267.

Arimitsu, M.L., J.F. Piatt, M.D. Romano, M.A. Litzow, A.A. Abbookire, and M. Robards. *In press*. Distribution and spawning dynamics of Pacific capelin (*Mallotus villosus*) in the nearshore and pelagic habitats of Glacier Bay National Park, Alaska. *Journal Name?*

Arimitsu, M.L., M.A. Litzow, J.F. Piatt, M.D. Robards, A.A. Abookire, and G.S. Drew. 2003. Inventory of marine and estuarine fishes in Southeast and Central Alaska National Parks. Nat. Park. Serv. Alaska Region. Inventory and Monitoring Program Final Rep., USGS Alaska Science Center, Anchorage, Alaska.

Arimitsu, M.L., and J.F. Piatt. 2004. Field guide to identifying Kittlitz's Murrelet forage fish. USGS Alaska Science Center, Anchorage, Alaska.

Arndt, A.A., K.A. Echelmeyer, W.D. Harrison, C.S. Lingle, and V.B. Valentine. 2002. Rapid wastage of Alaska glaciers and their contribution to rising sea level. *Science* 297: 382-386.

Carter, H.R. and S.G. Sealy. 1987. Fish-holding behavior of Marbled Murrelets. *Wilson Bulletin* 99: 289-291.

Day, R.H. 1995. New information on Kittlitz's Murrelet nests. *Condor* 97: 271-273.

Day, R.H. 1996. Nesting phenology of Kittlitz's Murrelet. *Condor* 98: 433-437.

Day, R.H., K.L. Oakley, and D.R. Darnard. 1983. Nest sites and eggs of Kittlitz's and Marbled Murrelets. *Condor* 85: 265-273.

Day, R.H., K.J. Kuletz, and D.A. Nigro. 1999. Kittlitz's Murrelet (*Brachyramphus brevirostris*). In *The Birds of North America*, No. 435 (A. Poole and F. Gill, eds.). The Birds of North America, Inc., Philadelphia, PA.

Day, R.H., and D.A. Nigro. 2000. Feeding ecology of Kittlitz's and Marbled Murrelets in Prince William Sound, Alaska. *Waterbirds* 23(1): 1-14.

Day, R.H., A.K. Prichard, and D.A. Nigro. 2003. Ecological specialization and overlap of *Brachyramphus* murrelets in Prince William Sound, Alaska. *Auk* 120(3): 680-699.

Frederiksen, M., M.P. Harris, F. Daunt, P. Rothery, and S. Wanless. 2004. Scale-dependent climate signals drive breeding phenology of three seabird species. *Global Climate Biology* 10: 1214-1221.

- Kuletz, K.J., and S.J. Kendall. 1998. A productivity index for marbled murrelets in Alaska based on surveys at sea. *Journal of Wildlife Management* 62: 446-460.
- Montevecchi W.A. 1993. Birds as indicators of change in marine prey stocks. *In* Birds as monitors of environmental change. *Eds.* R. W. Furness and J. J. D. Greenwood. Chapman and Hall, London, U.K.
- Naslund, N.L., J.F. Piatt, and T. van Pelt. 1994. Breeding behavior and nest site fidelity of Kittlitz's Murrelet. Abstracts of Pacific Seabird Group meeting, 26-29 January 1994: 33-34, Sacramento, CA.
- Naslund, N.L., and B.P. O'Donnell. 1995. Daily patterns of Marbled Murrelet activity at inland sites. Pages 129-134 in *Ecology and conservation of the Marbled Murrelet* (C.J. Ralph, G.L. Hunt, Jr., M.G. Raphael and J.F. Piatt, Eds.). General Technical Report PSW-152. U.S. Department of Agriculture, Forest Service, Pacific Southwest Research Station, Albany, CA.
- Piatt, J. F., N. L. Naslund, and T. I. van Pelt. 1994. Nest-site selection and fidelity in Kittlitz's Murrelet. *Beringian Seabird Bulletin* 2: 54-56.
- Piatt, J.F., and P. Anderson. 1996. Response of common murrelets to the Exxon Valdez oil spill and long-term changes in the Gulf of Alaska marine ecosystem. In Rice, S.D., Spies, R.B., Wolfe, D.A., Wright, B.A. (*Eds.*), *Proc. Exxon Valdez Oil Spill Symposium*, American Fisheries Society Symposium No. 18, American Fisheries Society, Bethesda, MD.
- Sealy, S.G. 1974. Breeding phenology and clutch size in the Marbled Murrelet. *Auk* 91: 10-23.
- Speckman, S.G., J.F. Piatt, and A.M. Springer. 2003. Deciphering the social structure of marbled murrelets from behavioral observations at sea. *Waterbirds* 26: 266-274.
- Speckman, S.G., J.F. Piatt, and A.M. Springer. 2004. Small boats disturb fish-holding Marbled Murrelets. *Northwest Naturalist* 85: 32-34.
- Strachan, G., M. McAllister, and C. J. Ralph. 1995. Marbled Murrelet at-sea and foraging behavior. Pages 247-253 in *Ecology and conservation of the Marbled Murrelet* (C.J. Ralph, G.L. Hunt, Jr., M.G. Raphael and J.F. Piatt, Eds.). General Technical Report PSW-152. U.S. Department of Agriculture, Forest Service, Pacific Southwest Research Station, Albany, CA.
- Tranquilla, L.M., N.R. Parker, R.W. Bradley, D.B. Lank, E.A. Krebs, L. Loughheed, and C. Loughheed. 2005. Breeding chronology of Marbled Murrelets varies between coastal

and inshore sites in southern British Columbia. *Journal of Field Ornithology* 76(4): 357-367.